

stonewood<sup>®</sup>  
*inspiring living space*

CANNE  
COLLECTION  
PRICE LIST  
2022



**INDEX**

<b>2</b>	Price groups
<b>3</b>	Technical features
<b>4</b>	Finishes
<b>6</b>	Handles
<b>8</b>	Feet
<b>9</b>	Special featurings
<b>10</b>	Price-list Icons

**D.45,5 model**

<b>12</b>	Smart uniblocks
<b>13</b>	Wall-hung base units
<b>16</b>	Floor-standing base units
<b>18</b>	Optional finishing sides

**D.35-51 model**

<b>20</b>	Uniblock for fitted basins
<b>24</b>	Optional finishing sides
<b>25</b>	ART lateral legs
<b>26</b>	Tops and 45° bevelled sides
<b>27</b>	Th.1,2 cm tops and sides
<b>28</b>	H.24 cm wall-hung base units
<b>30</b>	H.36 cm wall-hung base units
<b>32</b>	H.48 cm wall-hung base units
<b>36</b>	H.60 cm wall-hung base units
<b>40</b>	H.72+4 cm floor-standing base units
<b>44</b>	H.84+4 cm floor-standing base units
<b>48</b>	Wall units
<b>56</b>	Wall units COMBO
<b>58</b>	Open wall units
<b>61</b>	Wall-hung tall units
<b>70</b>	Floor-standing tall units

**ACCESSORIES**

<b>73</b>	Q Accessories
<b>74</b>	Mirrors
<b>76</b>	Lamps
<b>77</b>	WRAP Consoles

**78 Tops****91 Compositions**

## Price Groups

13	2	3
<b>Polymeric</b>	<b>Matt White</b>	<b>Matt Colour</b>
Bronze Metallik Rovere Grain Dark Rockford Burbon Oak Thermo A Fruit Wood	Matt White	<b>48</b> Matt Colours (see Samples)

### Handle grip

Other dedicated handles are available, please specify with order

### Metal drawers

GRASS metallic sliding system in Anthracite finish with amortized return, metallic carter, clasping-unclasping rapid system.

### Shelves

5mm smoked glass as standard.

### Plinth

Floor-standing H.4 cm in MDF coated in Anthracite finish.

## METAL FINISHES

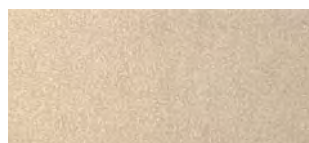

S11 Art Brass



S03 Brushed Bronze

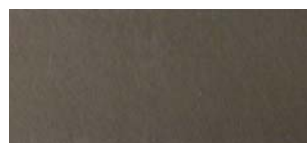

S05 Oxide



Anthracite internal finish



Anthracite plinth H. 4 cm



Foot H.21 and 33 cm Metal finishes optional

## Technical characteristics

<div style="background-color: #333; color: white; padding: 5px; text-align: center; font-weight: bold;">13</div> <div style="border: 1px solid black; padding: 5px; text-align: center; font-weight: bold;">Polymeric</div>	<b>Carcass</b>	Made with chipboard panel in E1 class, internal finish in Anthracite melamine = CARB PH2 COMPLIANT. Sides in view made with MDF coated Polymeric, finished as fronts.. When side panels are used, all carcass is made in anthracite melamine.
	<b>Fronts</b>	Made with MDF coated Polymeric, internal side Anthracite = CARB PH2 COMPLIANT.
	<b>Optional finishing sides</b>	Made with MDF coated Polymeric, internal side Anthracite = CARB PH2 COMPLIANT.

<div style="background-color: #333; color: white; padding: 5px; text-align: center; font-weight: bold;">2</div> <div style="border: 1px solid black; padding: 5px; text-align: center; font-weight: bold;">Matt White</div>	<b>Carcass</b>	Made with chipboard panel in E1 class, internal finish in Anthracite melamine = CARB PH2 COMPLIANT. Sides in view finished Matt White lacquered.
	<b>Fronts</b>	Made with MDF internal / external matt White lacquered.
	<b>Optional finishing sides</b>	Made with MDF internal / external matt White lacquered.

<div style="background-color: #333; color: white; padding: 5px; text-align: center; font-weight: bold;">3</div> <div style="border: 1px solid black; padding: 5px; text-align: center; font-weight: bold;">Matt Colour</div>	<b>Carcass</b>	Made with chipboard panel in E1 class, internal finish in Anthracite melamine = CARB PH2 COMPLIANT. Sides in view finished as fronts.
	<b>Fronts</b>	Made with MDF internal / external lacquered, 48 Matt Colours available.
	<b>Optional finishing sides</b>	Made with MDF internal / external lacquered, 48 Matt Colours available.



### GLASS FRONTS

Made with black aluminum profile and 4mm Stop-Sol glass, special treatment makes surface slightly reflective. These fronts can only fit PROFILO handle in matt black finish, fixing is made with high resistance bi-adhesive.

## Carcass internal finishes



Internal finish **ANTHRACITE**

Polymeric  
price group **13**



**184X** Bronze Metallik

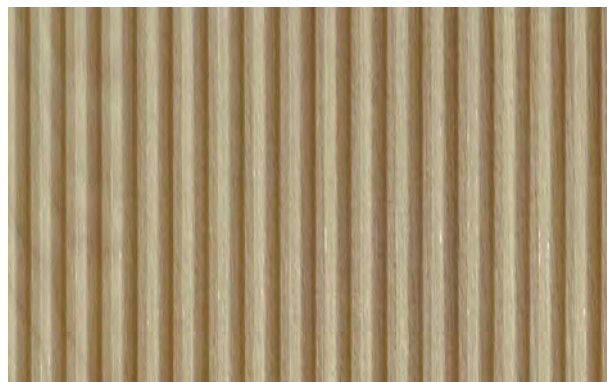

**183X** Rovere Grain



**186X** Dark Rockford

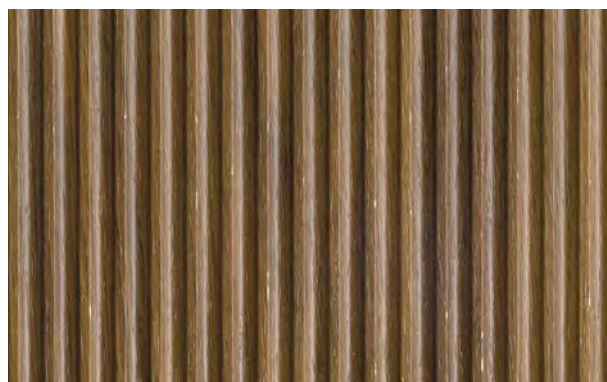

**187X** Burbon Oak

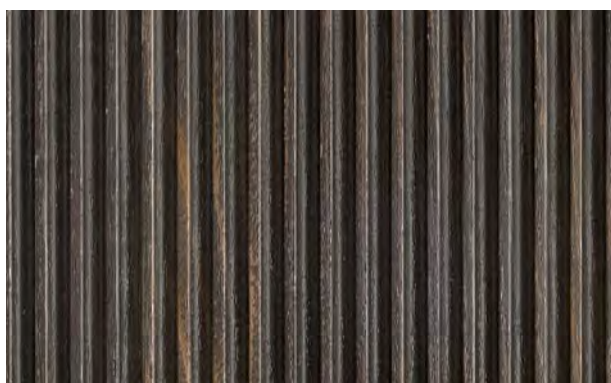

**188X** Thermo A



**189X** Fruit Wood

**NOTE: Door internal finish ANTHRACITE as carcass.**

## Matt White

price group **2**



Matt White

## Matt Colour

price group **3**

**Extra Series RAL colours + 300,00**  
delivery +10 working days

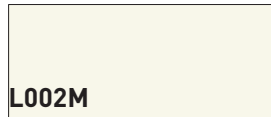

**L002M**

Pure White



**L003M**

Grey White

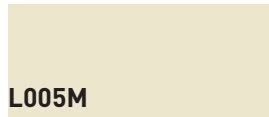

**L005M**

Pearl White

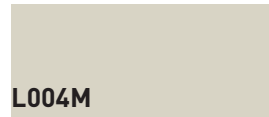

**L004M**

Pergamon



**L005M**

Sahara



**L056M**

Argilla



**L057M**

Talpa



**L006M**

Light Grey

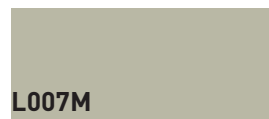

**L007M**

Silk Grey



**L008M**

Pebble Grey



**L009M**

Agate Grey



**L010M**

Platinum Grey



**L011M**

Signal Grey



**L012M**

Dusty Grey



**L013M**

Stone Grey



**L014M**

Concrete Grey



**L015M**

Mouse Grey



**L016M**

Quartz Grey



**L017M**

Blue Grey



**L018M**

Basalt Grey



**L019M**

Graphite Grey



**L021M**

Terra Beige



**L022M**

Grey Beige

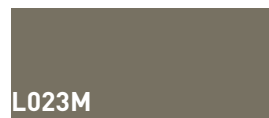

**L023M**

Beige Grey



**L024M**

Terra Brown



**L025M**

Grey Brown



**L026M**

Rape Yellow



**L027M**

Honey Yellow



**L028M**

Yellow Orange



**L030M**

Signal Red



**L031M**

Purple Red

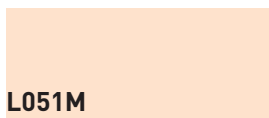

**L051M**

Cipria



**L032M**

Claret Violet



**L035M**

Pastel Violet



**L036M**

White Green



**L052M**

Lime



**L040M**

Moss Green



**L042M**

Turquoise Blue



**L043M**

Water Blue



**L044M**

Blue Green

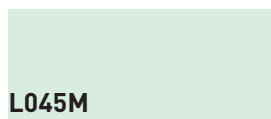

**L045M**

Light Blue



**L054M**

Bruma



**L053M**

Tiffany



**L046M**

Pastel Blue



**L047M**

Azure Blue



**L048M**

Ocean Blue



**L049M**

Graphite Black



**L050M**

Jet Black

# Handles

## CYLINDER



Handle in Ø 18 mm. Extruded aluminum  
Always placed in the middle of the front, higher side on units, lower side on wall units.

**Cannot match aluminum frontas with stop-sol glass**

Ø	H.	STANDARD FINISHES	METAL FINISHES WITH SURCHARGE
18 mm	120 mm	Matt Black	Art Brass Brushed Bronze Oxide
			<b>Surcharge code MG242 33,00/ handle</b>

## PROFILO

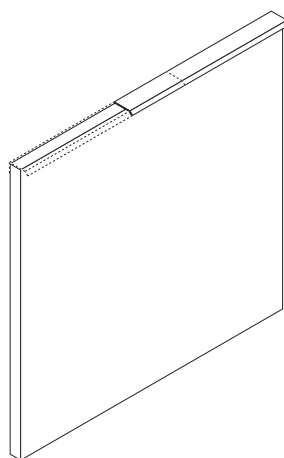

### OPTIONAL METAL FINISHES

S11 Art Brass

S03 Brushed Bronze

S05 Oxide

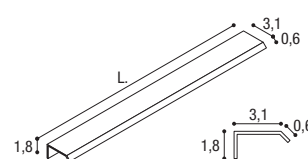
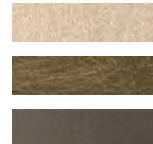

It may be ordered in other coloured finishes **ONLY** combined with vanities in the same color.

**Important:**  
**PROFILO handle in Matt Black, is the only available for black aluminum frontas with stop-sol glass.**  
**Fixing is made with high resistance bi-adhesive.**

Code	W. HANDLE	W. BASE UNIT	STANDARD FINISHES	FINISHES WITH SURCHARGE
MA180	170 mm	25-35	Matt White Matt Black	Matt lacquered matching with furniture Art Brass Brushed Bronze Oxide
MA181	300 mm	50-60		<b>Surcharge code MG248 22,00/ handle</b>
MA182	450 mm	70-80-90		
MA183	600 mm	100-120		



## Positioning on BASE UNITS

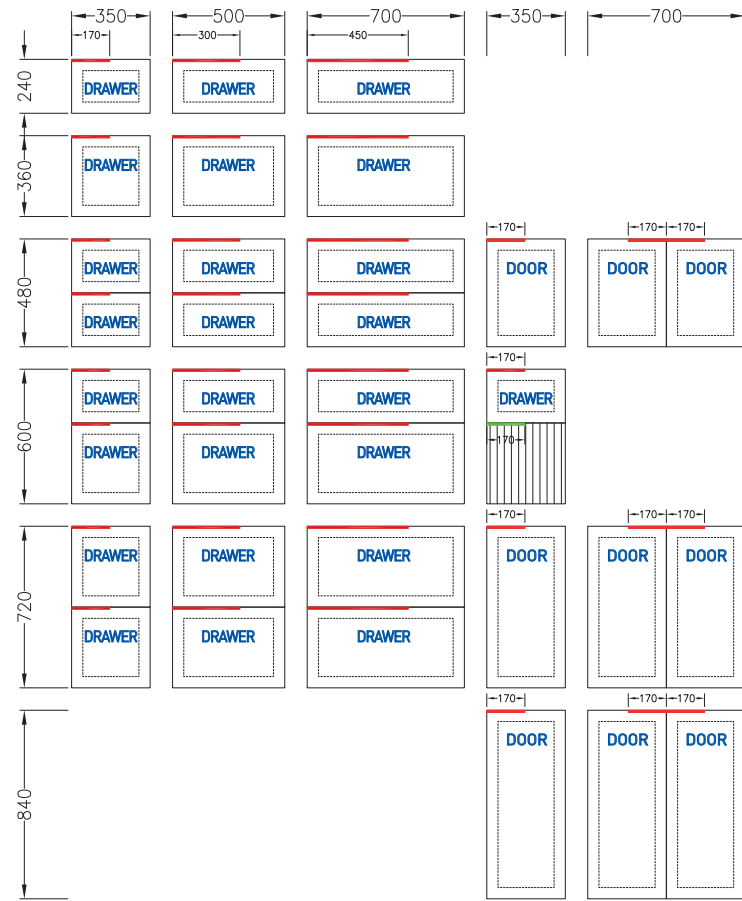

## Positioning on TALL UNITS

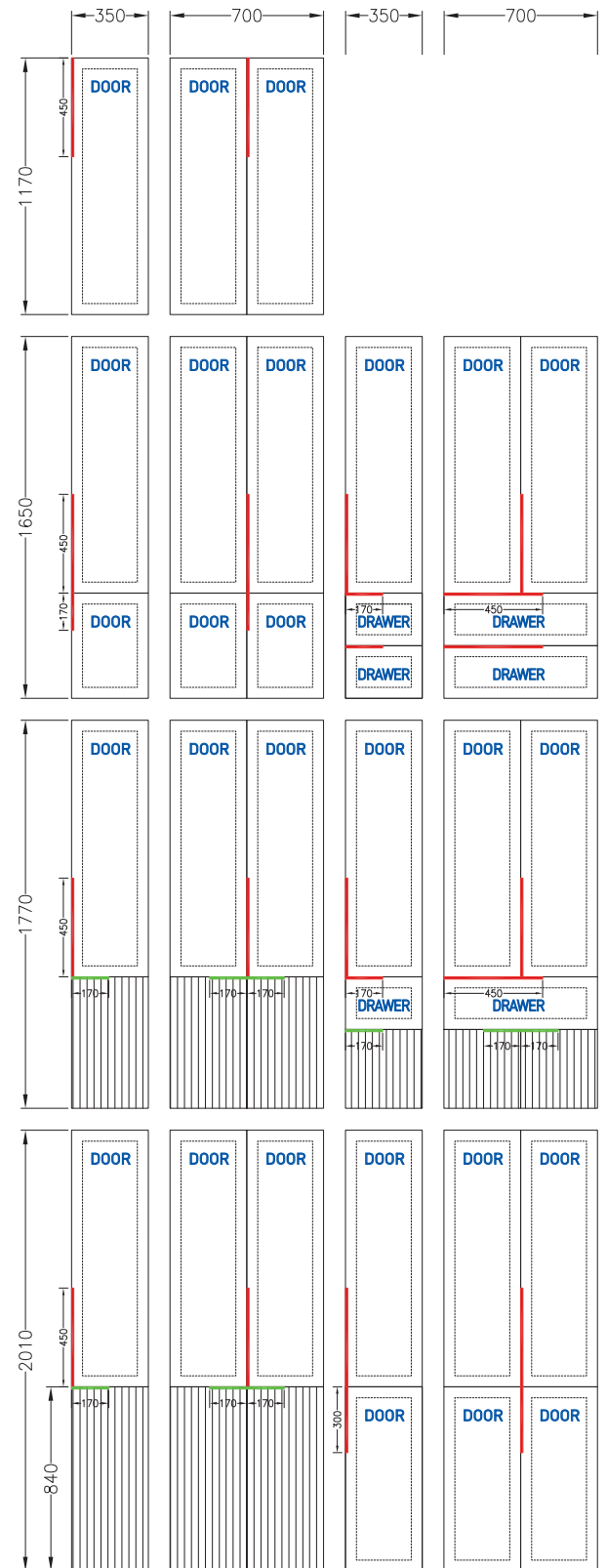

## Positioning on WALL UNITS

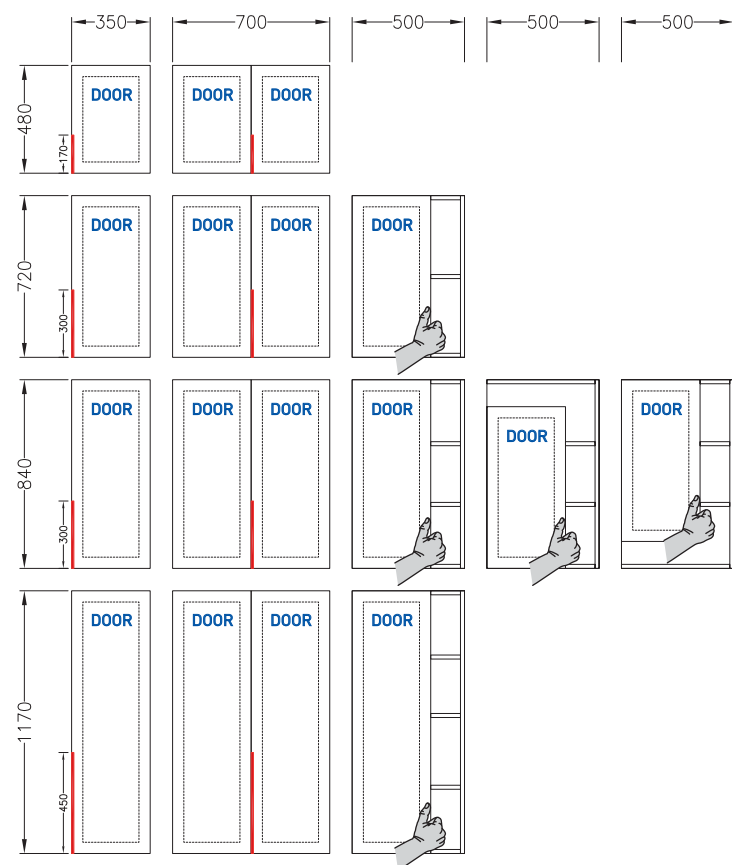

**On W. 70 cm WALL UNITS and TALL UNITS with 2 doors, it's provided only one handle.**



**WITHOUT HANDLE**

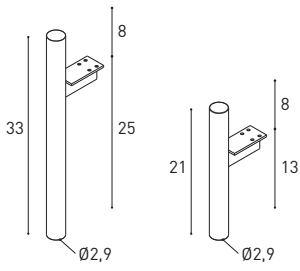

**VERTIGO foot is made in metal tube, with regulation**  
**NON-bearing element, always fix units and columns to the wall.**

H	Code	Matt Black Price	Art Brass Brushed Bronze Oxide Price
<b>21</b>	<b>PI150</b>	66 each	105 each
<b>33</b>	<b>PI160</b>	72 each	110 each

H.72 INTEGRATED BASIN

H.60 OVERSTANDING BASIN

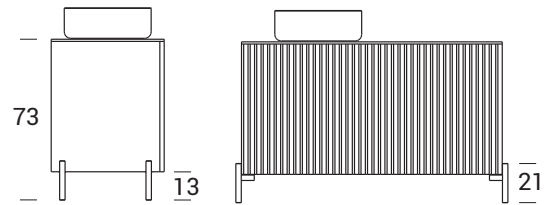
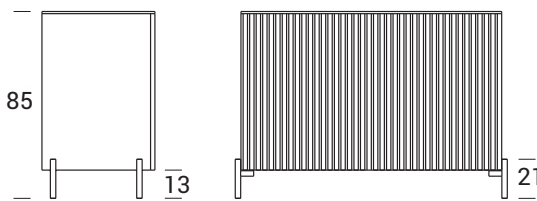
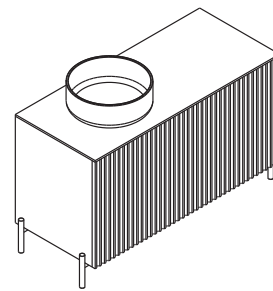
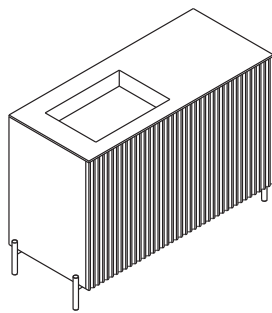

H.60 INTEGRATED BASIN

H.48 OVERSTANDING BASIN

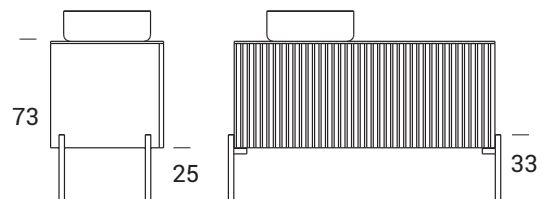
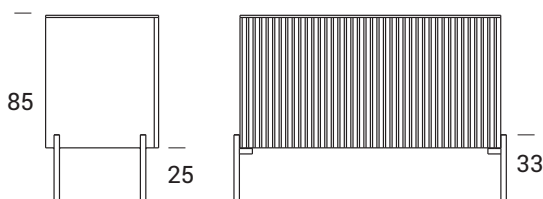
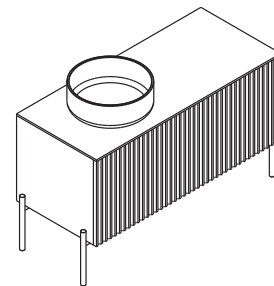
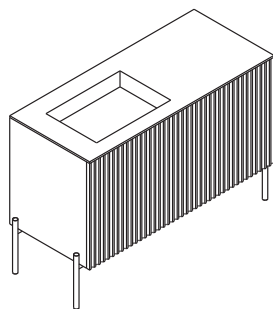

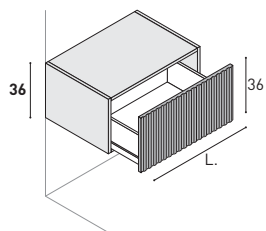
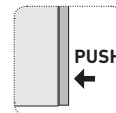

code BA1608C

n° 1 **MG247** 72

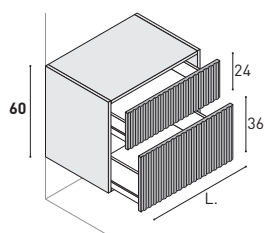

code BA956C

n° 2 **MG247** 72 x 2

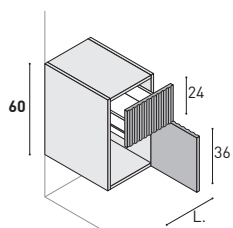

code BA944C

n° 1 **MG247** 72

n° 1 **MG246** 11

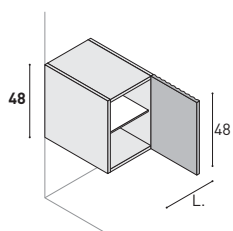

code BA1440

n° 1 **MG246** 11

## Price-list Icons

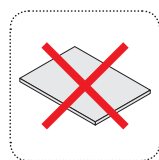

Item supplied without top  
**To add**

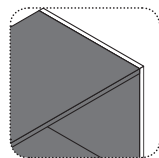

Structure / Drawers Anthracite finish

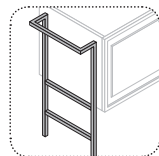

Suitable element for matching with Structura  
**Only for base units D.51 cm (see on pages 490-491 General Price-list)**

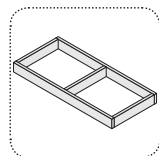

Suitable element for internal drawer partitions  
**Only for base units D.51 cm (see on page 504 General Price-list)**

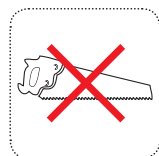

NOT suitable for special featurings

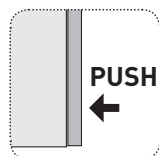

**Compatible with Push-pull opening**

For each front:

Door	<b>MG246</b>	11
Drawer	<b>MG247</b>	72



NOT compatible with Push-pull opening

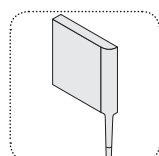

Compatible with ART LEG  
(see page 25)

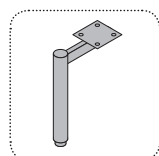

Vertigo feet  
(see page 8)



2 LED lights kit, with sensor (12V - K°4000 - 9,6W/ml)

**MG105** 198 each part



Item referred to General Pricelist

DEPTH 45.5CM  
MODEL

	Price Groups		
	13	2	3
	Polymeric	Matt White	Matt Colour

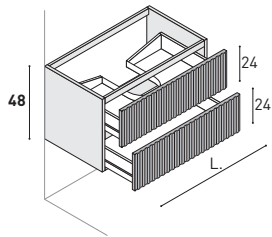

**Uniblock 2 jumbo metal drawers.**  
Not compatible with PUSH-PULL



D	W	Code	13	2	3
45,5	60	<b>MB201C</b>	509	535	555
	80	<b>MB202C</b>	560	589	611
	100	<b>MB203C</b>	610	641	665
	120	<b>MB204C</b>	655	688	714

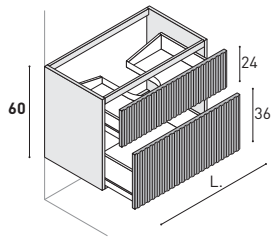

**Uniblock 2 jumbo metal drawers.**  
Not compatible with PUSH-PULL



D	W	Code	13	2	3
45,5	60	<b>MB211C</b>	586	615	638
	80	<b>MB212C</b>	642	675	700
	100	<b>MB213C</b>	697	732	759
	120	<b>MB214C</b>	748	786	817

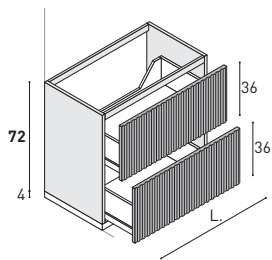

**Uniblock 2 jumbo metal drawers.**  
Not compatible with PUSH-PULL



D	W	Code	13	2	3
45,5	60	<b>MB221C</b>	687	722	750
	80	<b>MB222C</b>	753	791	821
	100	<b>MB223C</b>	820	862	895
	120	<b>MB224C</b>	884	929	964

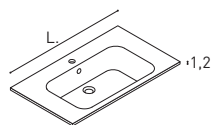

**SPEED console.**

matt White Mineraltek  
1 tap hole  
Basin **WITH** overflow hole

D	W	Code	MATT White
46	60	<b>CC4060</b>	231
	80	<b>CC4080</b>	302
	100	<b>CC4100</b>	336
	120	<b>CC4120</b>	391

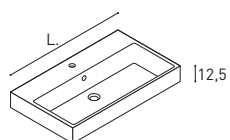

**SLIM Console.**

Matt White finish: delivery 6 weeks

Matt and Glossy White Ceramic  
1 tap hole

D	W	Code	GLOSSY White	Code	MATT White
46,2	60	<b>CS06040</b>	344	<b>CS06041</b>	469
	80	<b>CS08040</b>	451	<b>CS08041</b>	615
	100	<b>CS10040</b>	550	<b>CS10041</b>	737
	120	<b>CS12040</b>	687	<b>CS12041</b>	916

	Price Groups		
	13	2	3
	Polymeric	Matt White	Matt Colour

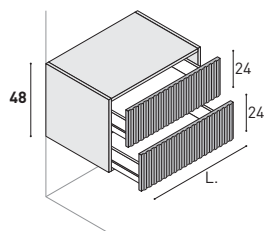

**Base unit 2 jumbo metal drawers.**

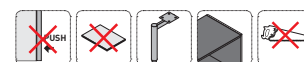

Page 5

D	W	Code	13	2	3
<b>45,5</b>	35	<b>BA1110C</b>	402	423	438
	50	<b>BA1111C</b>	434	456	473
	60	<b>BA1112C</b>	458	481	500
	70	<b>BA1113C</b>	491	516	536
	80	<b>BA1114C</b>	515	542	563
	90	<b>BA1115C</b>	539	567	589
	100	<b>BA1116C</b>	570	599	622
	120	<b>BA1117C</b>	638	670	697

RH as drawer

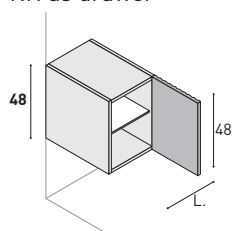

**Base unit 1 door, 1 glass shelf.**

RH-LH version.

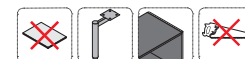

Page 5

D	W	Code	13	2	3
<b>45,5</b>	35	<b>BA1032</b>	225	237	246

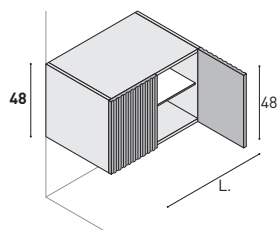

**Base unit 2 doors, 1 glass shelf.**

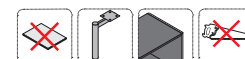

Page 5

D	W	Code	13	2	3
<b>45,5</b>	70	<b>BA1063</b>	339	357	370

RH as drawer

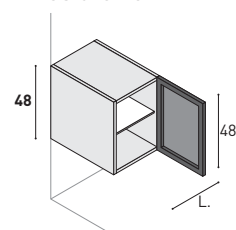

**Base unit 1 door with black aluminium frame + Stop-sol glass, 1 glass shelf.**

RH-LH version.



Page 5

D	W	Code	13	2	3
<b>45,5</b>	35	<b>BV1032</b>	337	355	368

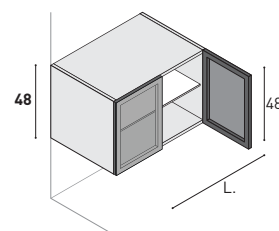

**Base unit 2 doors with black aluminium frame + Stop-sol glass, 1 glass shelf.**

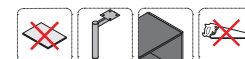

Page 5

D	W	Code	13	2	3
<b>45,5</b>	70	<b>BV1063</b>	572	601	624

	Price Groups		
	13	2	3
	Polymeric	Matt White	Matt Colour

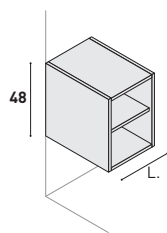

### Open base unit 1,8 cm Th, 1 wooden shelf.



D	W	Code	13	2	3
<b>45,5</b>	25	<b>BA1212</b>	-	308	322
	35	<b>BA1213</b>	-	350	365
	50	<b>BA1219</b>	-	402	418
	60	<b>BA1215</b>	-	432	449
	70	<b>BA1216</b>	-	469	489

RH as drawer

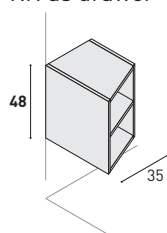

### Open base unit, for changing depths, 1 wooden shelf



D	W	Code	13	2	3
<b>45,5/21</b>	35	<b>BTG4N6</b>	-	363	379
<b>45,5/35</b>	35	<b>BTG4N7</b>	-	381	396

RH as drawer

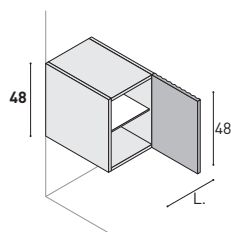

### Base unit 1 door, 1 glass shelf.

Versione DX-SX.

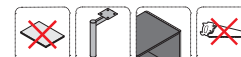

Page 5

D	W	Code	13	2	3
<b>21</b>	35	<b>BA1031</b>	182	192	198
<b>35</b>	35	<b>BA1040</b>	201	212	219

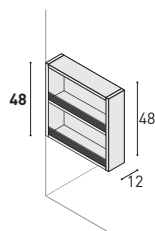

### End reversible void element H.48 cm with anti-fall glass.

Element NOT for individual sale.



D	W	Code	13	2	3
<b>45,5</b>	12	<b>BA42L1</b>	-	251	262



	Price Groups		
	13	2	3
	Polymeric	Matt White	Matt Colour

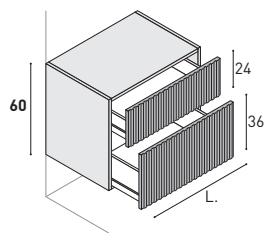

### Base unit 2 jumbo metal drawers.

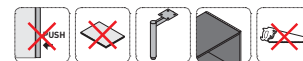

Page 5

D	W	Code	13	2	3
<b>45,5</b>	35	<b>BA1120C</b>	457	480	499
	50	<b>BA1121C</b>	498	523	543
	60	<b>BA1122C</b>	525	552	572
	70	<b>BA1123C</b>	553	581	603
	80	<b>BA1124C</b>	579	609	632
	90	<b>BA1125C</b>	605	636	660
	100	<b>BA1126C</b>	640	673	698
	120	<b>BA1127C</b>	693	729	756

RH as drawer

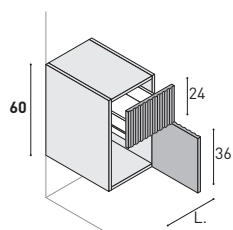

### Base unit 1 metal drawer, 1 door.

RH-LH version.

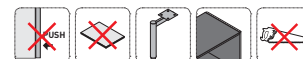

Page 5

D	W	Code	13	2	3
<b>45,5</b>	35	<b>BA1127</b>	352	370	384

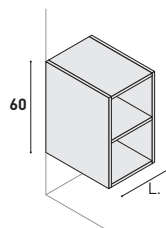

### Open base unit 1,8 cm Th, 1 wooden shelf.



D	W	Code	13	2	3
<b>45,5</b>	25	<b>BG533</b>	-	326	339
	35	<b>BG534</b>	-	357	371
	50	<b>BG536</b>	-	416	434
	60	<b>BG537</b>	-	447	466
	70	<b>BG538</b>	-	479	499

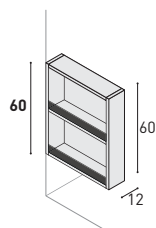

### End reversible void element H.60 cm with anti-fall glass.

Element NOT for individual sale.



D	W	Code	13	2	3
<b>45,5</b>	12	<b>BA62L1</b>	-	290	302

	Price Groups		
	13	2	3
	Polymeric	Matt White	Matt Colour

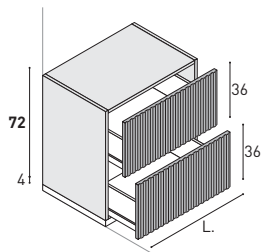

### Base unit 2 jumbo metal drawers.

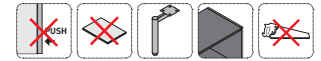

Page 5

D	W	Code	13	2	3
<b>45,5</b>	35	<b>BA74D2</b>	495	521	541
	50	<b>BA74D3</b>	532	559	580
	60	<b>BA74D4</b>	568	597	620
	70	<b>BA74D5</b>	603	634	658
	80	<b>BA74D6</b>	638	670	697
	90	<b>BA74D7</b>	671	706	732
	100	<b>BA74D8</b>	699	734	763
	120	<b>BA74D9</b>	768	807	838

### RH as drawer

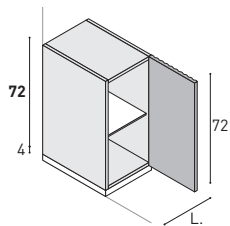

### Base unit 1 door, 1 glass shelf.

RH-LH version.



D	W	Code	13	2	3
<b>45,5</b>	35	<b>BA74N2</b>	289	304	315

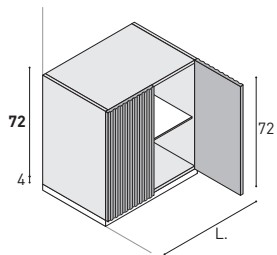

### Base unit 2 doors, 1 glass shelf.



D	W	Code	13	2	3
<b>45,5</b>	70	<b>BA74M5</b>	431	453	470

### RH as drawer

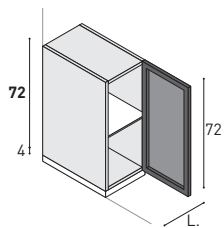

### Base unit 1 door with black aluminium frame + Stop-sol glass, 1 glass shelf.

RH-LH version.



D	W	Code	13	2	3
<b>45,5</b>	35	<b>BV74N2</b>	411	432	448

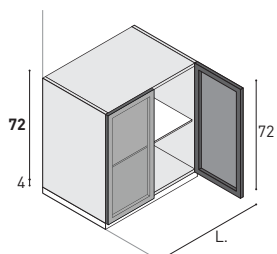

### Base unit 2 doors with black aluminium frame + Stop-sol glass, 1 glass shelf.



D	W	Code	13	2	3
<b>45,5</b>	70	<b>BV74M5</b>	684	719	745

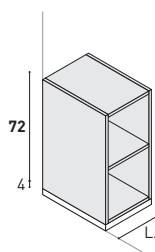

### Open base unit 1,8 cm Th, 1 wooden shelf.



D	W	Code	13	2	3
<b>45,5</b>	25	<b>BG74N1</b>	-	380	395
	35	<b>BG74N2</b>	-	396	413

	Price Groups		
	13	2	3
	Polymeric	Matt White	Matt Colour

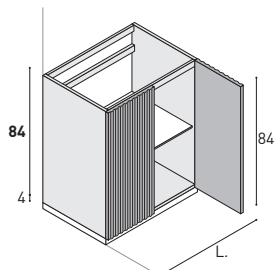

**Washbasin unit 2 doors, 1 glass shelf.**



D	W	Code	13	2	3
<b>45,5</b>	70	<b>BL84M5</b>	548	576	598

RH as drawer

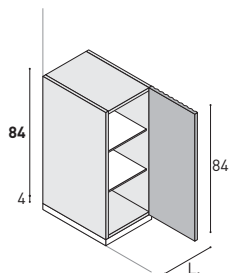

**Base unit 1 door, 2 glass shelves.**  
RH-LH version.

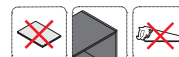

D	W	Code	13	2	3
<b>45,5</b>	35	<b>BA84N2</b>	284	299	311

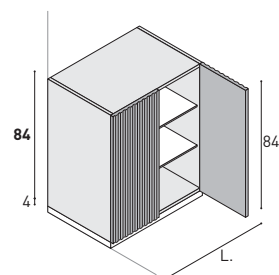

**Base unit 2 doors, 2 glass shelves.**



D	W	Code	13	2	3
<b>45,5</b>	70	<b>BA84M5</b>	440	462	480

RH as drawer

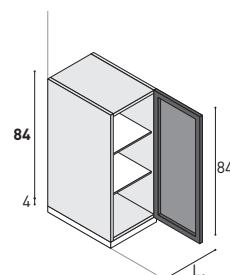

**Base unit 1 door with black aluminium frame + Stop-sol glass, 2 glass shelves.**  
RH-LH version.



D	W	Code	13	2	3
<b>45,5</b>	35	<b>BV84N2</b>	411	432	448

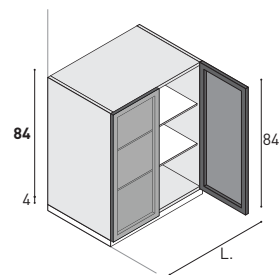

**Base unit 2 doors with black aluminium frame + Stop-sol glass, 2 glass shelves.**



D	W	Code	13	2	3
<b>45,5</b>	70	<b>BV84M5</b>	698	733	762

	Price Groups		
	13	2	3
	Polymeric	Matt White	Matt Colour

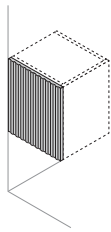

### Canneted side panel 1,9cm thick

When ordered, all unit's carcass become in anthracite finish

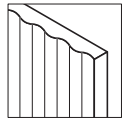

D	H	Code	13	2	3
45,5	48	<b>FN123</b>	65	118	118
	60	<b>FN124</b>	75	141	141
	72	<b>FN125</b>	85	151	151
	84	<b>FN126</b>	101	187	187

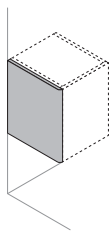

### Round shape smooth finish side 1,9 cm th.

Suggested with Solid-Surface or Glass tops

When ordered, all unit's carcass become in anthracite finish

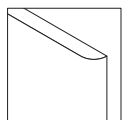

D	H	Code	13	2	3
45,5	48	<b>FC123</b>	62	65	65
	60	<b>FC124</b>	71	74	75
	72	<b>FC125</b>	81	84	85
	84	<b>FC126</b>	95	99	101

1,9 cm Th.

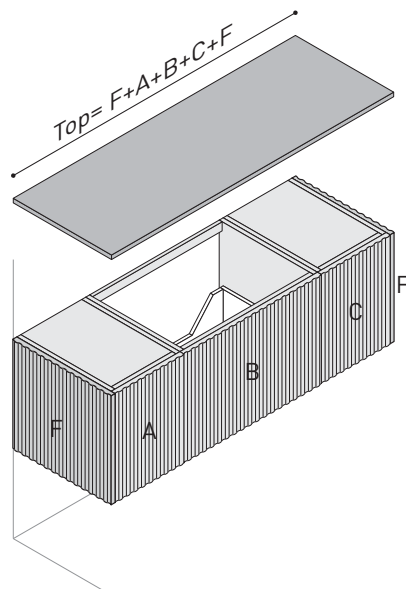

1,9 cm Th.  
curved

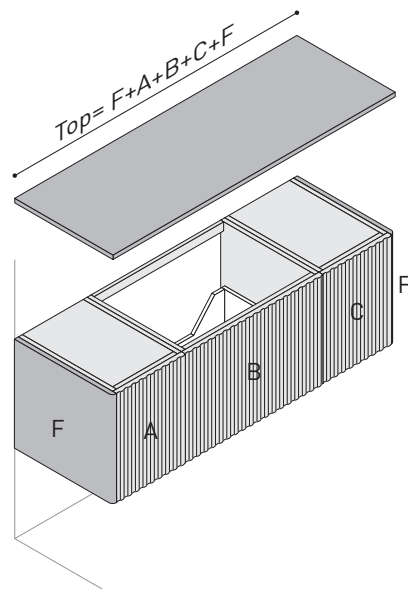

DEPTH 35-51CM  
MODEL

	Price Groups		
	13	2	3
	Polymeric	Matt White	Matt Colour

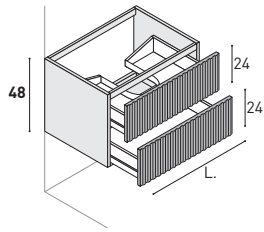

### Uniblock 2 jumbo metal drawers.



D	W	Code	13	2	3
<b>51</b>	60	<b>MB405C</b>	548	576	598
	70	<b>MB407C</b>	577	607	630
	80	<b>MB413C</b>	601	632	656
	90	<b>MB410C</b>	624	656	681
	100	<b>MB411C</b>	668	702	729
	120	<b>MB440C</b>	733	770	799

### SQUARE Console.

White Ceramic  
1 tap hole

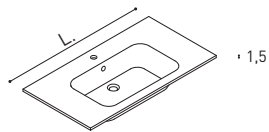

D	W	Basin	Code	Price	Data sheet
<b>51,5</b>	61	47,4	<b>CC5061</b>	322	
	71	57	<b>CC5071</b>	362	
	81	57	<b>CC5081</b>	400	
	91	57	<b>CC5091</b>	443	
	101	57	<b>CC5100</b>	535	
	121	57	<b>CC5121</b>	674	

LH as drawer

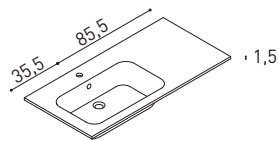

### SQUARE Console decentralised basin.

White Ceramic  
1 tap hole

RH as drawer

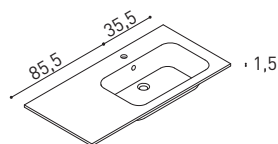

D	W	Code	Verse	Price	Data sheet
<b>51,5</b>	121	<b>CC5111</b>	LH	685	
		<b>CC5112</b>	RH		

### VARIO Console.

Mineraltek Glossy White  
1 tap hole  
Basin **WITHOUT** overflow hole

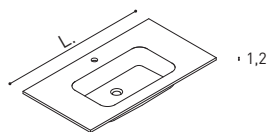

D	W	Basin	Code	Price	Data sheet
<b>51,5</b>	60,5	48	<b>CV0605</b>	352	
	70,5	55	<b>CV0705</b>	371	
	80,5	55	<b>CV0805</b>	425	
	90,5	55	<b>CV0905</b>	437	
	100,5	55	<b>CV1005</b>	493	
	120,5	55	<b>CV1205</b>	544	

LH as drawer

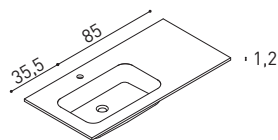

### VARIO Console decentralised basin.

Mineraltek Glossy White  
1 tap hole  
Basin **WITHOUT** overflow hole

RH as drawer

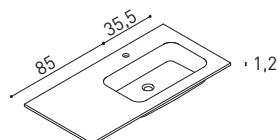

D	W	Code	Verse	Price	Data sheet
<b>51,5</b>	120,5	<b>CV1206</b>	LH	544	
		<b>CV1207</b>	RH		

# Uniblock for fitted basins

	Price Groups		
	13	2	3
	Polymeric	Matt White	Matt Colour

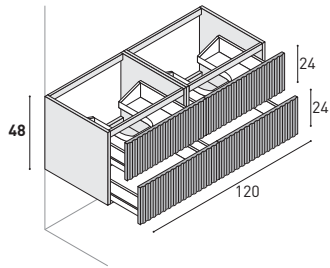

Uniblock 4 jumbo metal drawers.



D	W	Code	13	2	3
51	120	MB445C	1.005	1.055	1.096

## SQUARE Console 2 basins.

White Ceramic

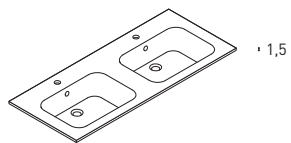

D	W	Code	Price	Data sheet
51,5	121	CC5122	701	

## VARIO Console 2 basins.

Mineraltek Glossy White Basin **WITHOUT** overflow hole

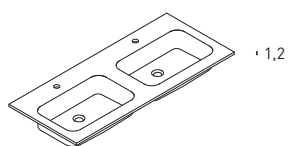

D	W	Code	Price	Data sheet
51,5	120,5	CV1205D	572	

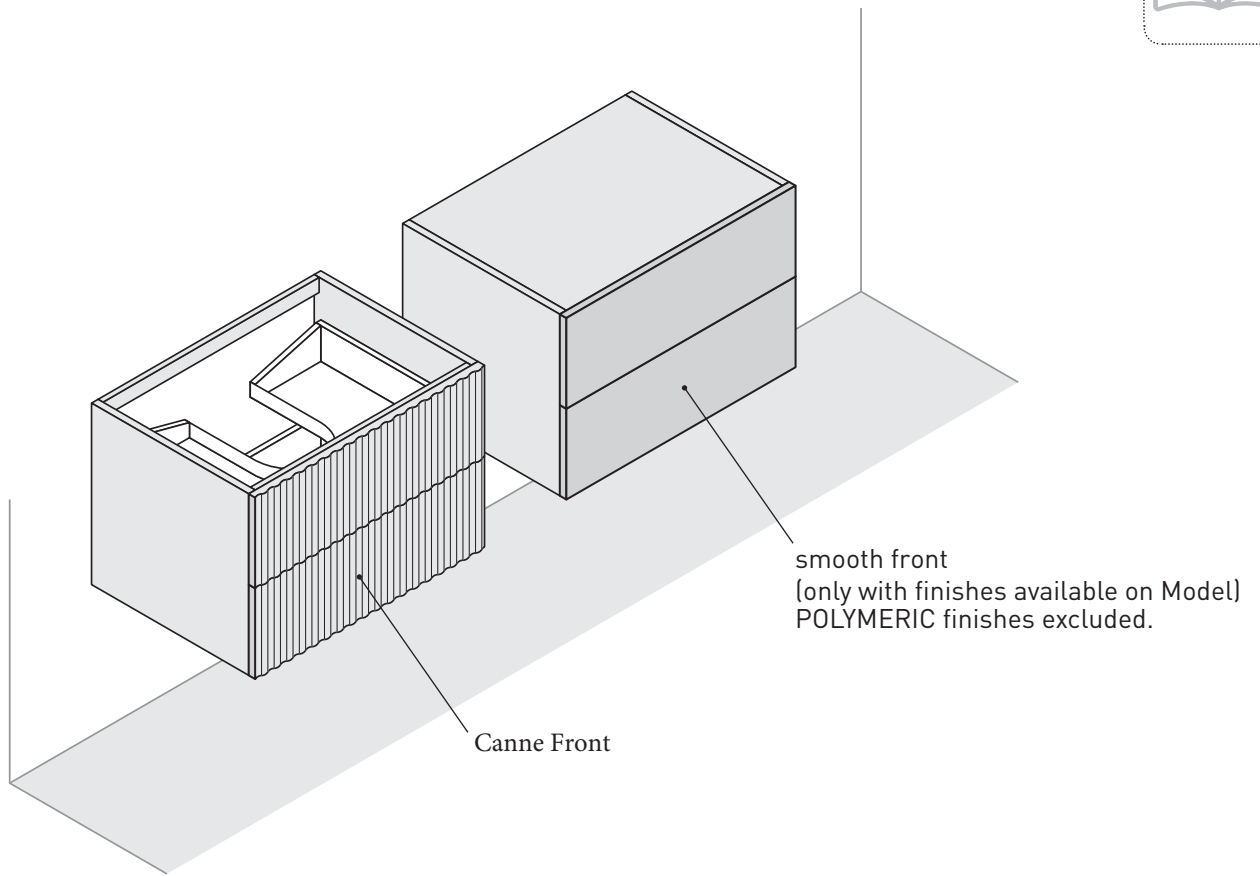



## SIMPLE MODULARITY

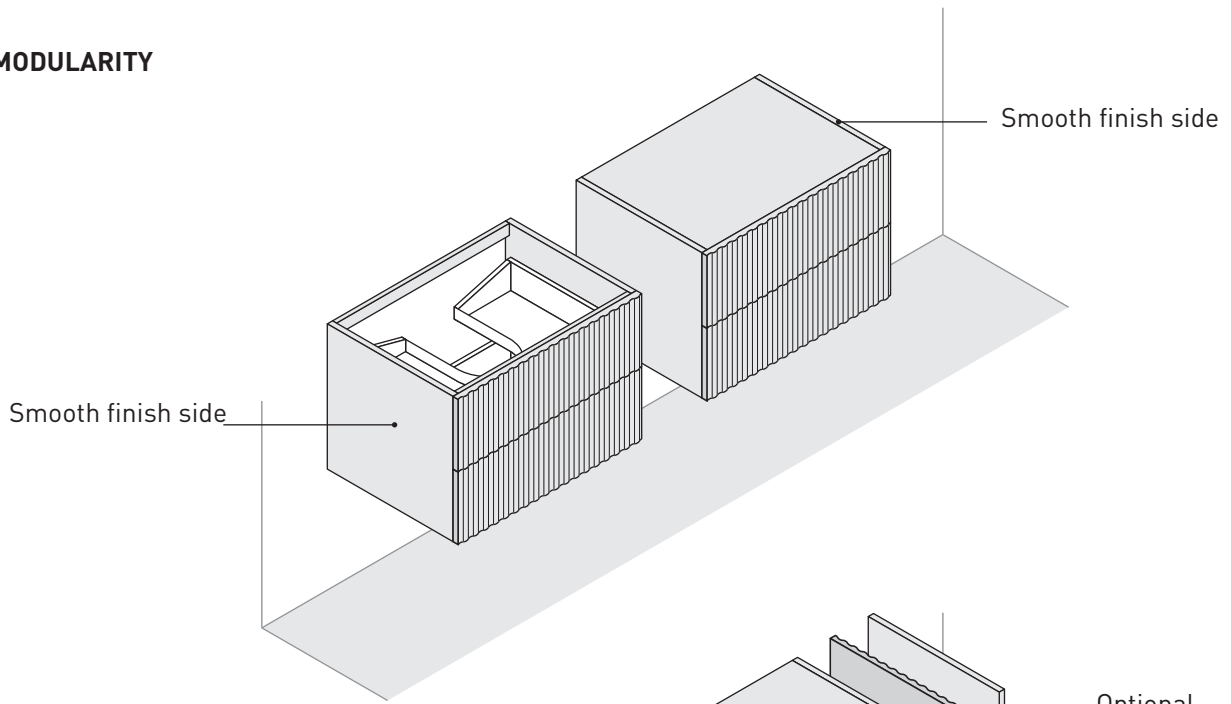

## WITH SIDE PANELS

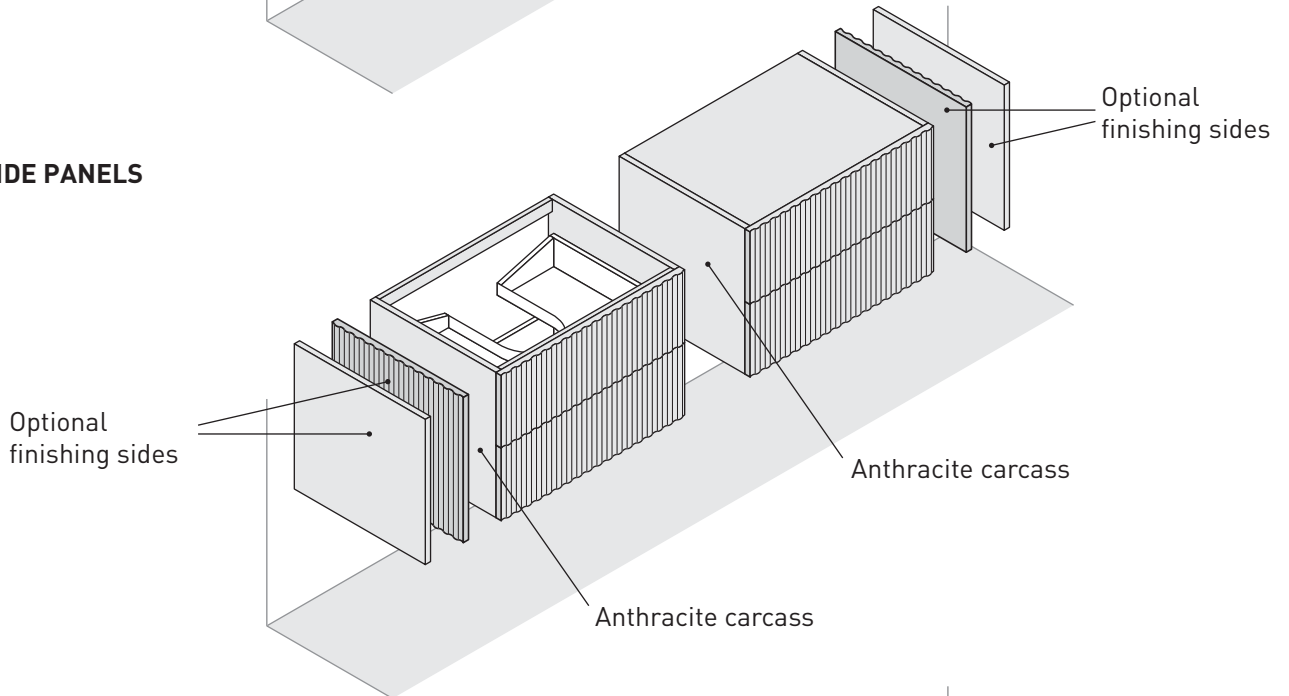

## MODULARITY WITH ART LEGS

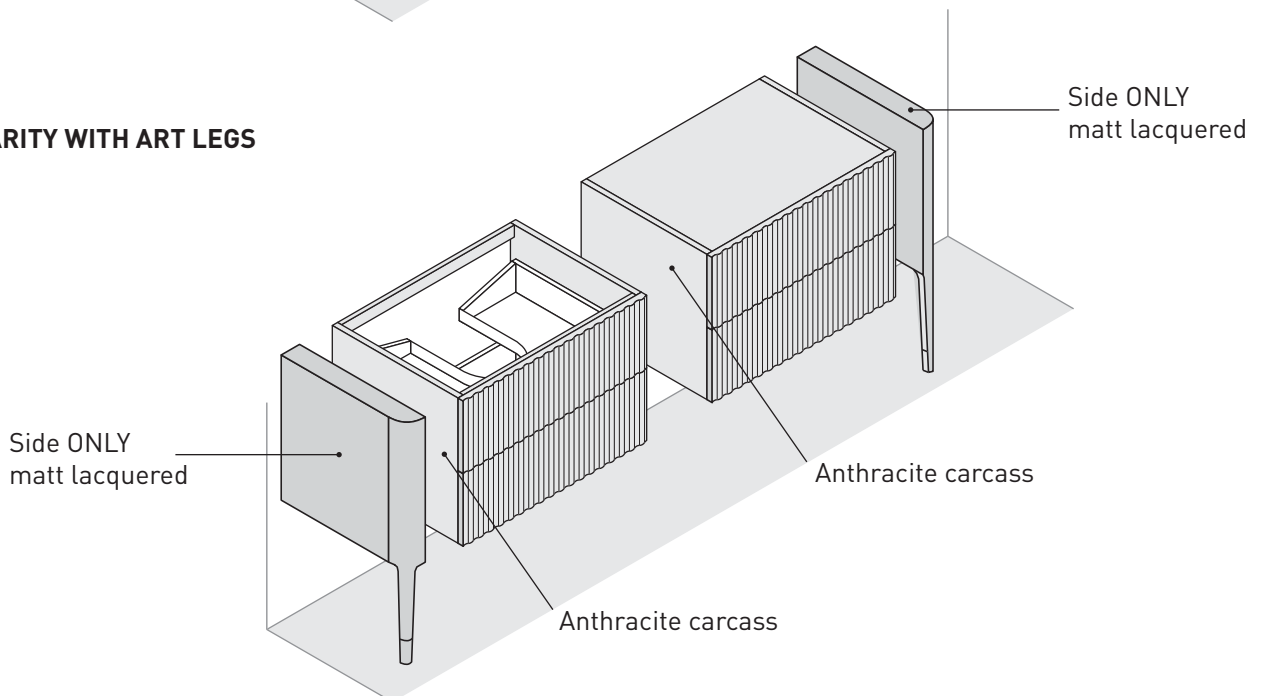

# VERTIGO optional finishing sides

	Price Groups		
	13	2	3
	Polymeric	Matt White	Matt Colour

## Canneted side panel 1,9cm thick

When ordered, all unit's carcass become in anthracite finish

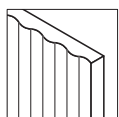
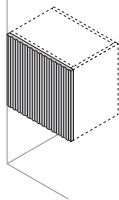

D	H	Code	13	2	3
35	24	FN101	44	93	93
	36	FN102	55	102	102
	48	FN103	65	118	118
	60	FN104	75	141	141
	72	FN105	85	151	151
	84	FN106	101	187	187
51	24	FN111	55	99	99
	36	FN112	69	118	118
	48	FN113	84	150	150
	60	FN114	99	182	182
	72	FN115	116	196	196
	84	FN116	132	245	245

## Round shape smooth finish side 1,9 cm th.

Suggested with Solid-Surface or Glass tops

When ordered, all unit's carcass become in anthracite finish

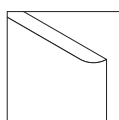
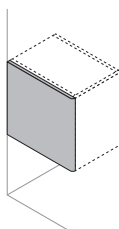

D	H	Code	13	2	3
35	24	FC101	42	44	44
	36	FC102	52	55	55
	48	FC103	62	65	65
	60	FC104	71	75	75
	72	FC105	81	85	85
	84	FC106	95	101	101
51	24	FC111	52	55	55
	36	FC112	64	68	68
	48	FC113	80	84	84
	60	FC114	94	99	99
	72	FC115	109	115	115
	84	FC116	126	132	132

1,9 cm Th.

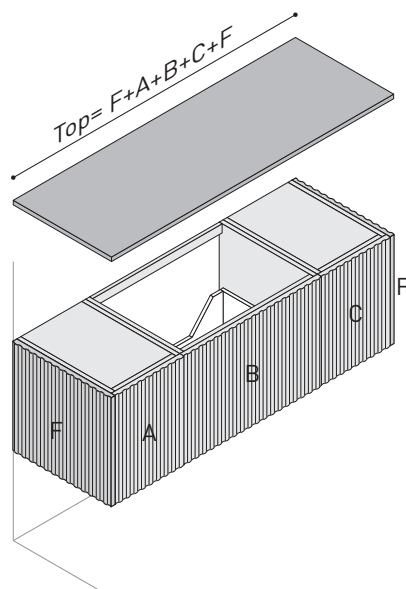

1,9 cm Th.  
curved

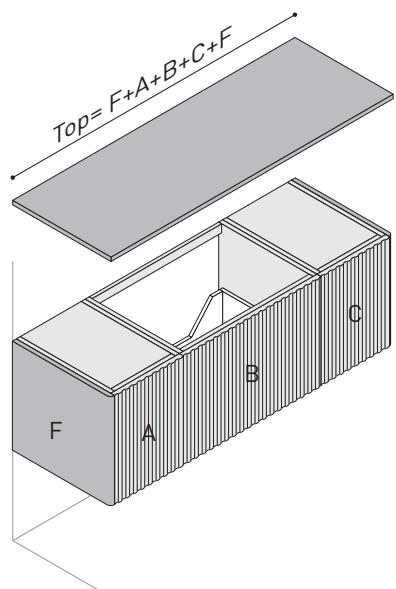

## ART lateral legs for combinations with over-top mounted basin

H. **73** cm

<b>ONLY lacquered finish</b>	Price Groups		
	13	2	3
	Polymeric	Matt White	Matt Colour

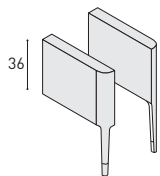

### Leg/side panel for H.36 base units.

Suggested only with Solid-Surface, Glass or Marbles tops

When ordered, all unit's carcass become in anthracite finish



	D	W	Code	13	2	3
single side	<b>51</b>	7	<b>GF578</b>	-	366	381
pair of sides	<b>51</b>	7+7	<b>GF573</b>	-	731	762

## ART lateral legs for compositions with integrated basin tops

H. **85** cm

	Price Groups		
	13	2	3
	Polymeric	Matt White	Matt Colour

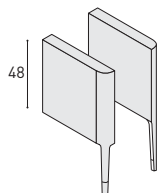

### Leg/side panel for H.48 base units.

Suggested only with Solid-Surface, Glass or Marbles tops

When ordered, all unit's carcass become in anthracite finish



	D	W	Code	13	2	3
single side	<b>51</b>	7	<b>GF588</b>	-	403	418
pair of sides	<b>51</b>	7+7	<b>GF585</b>	-	806	836

### Over-top mounted basin

Combinations with H.36 cm base units

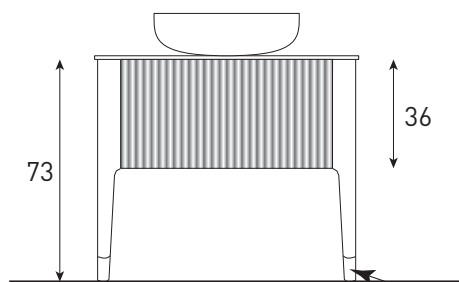

### Under-top mounted basin or integrated bowl

Combinations with H.48 cm base units

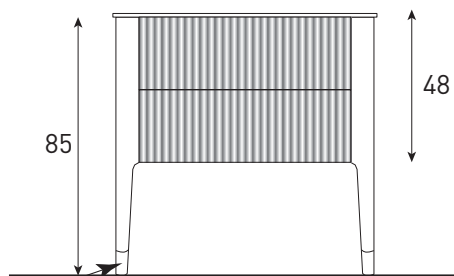

	Code	METAL FINISHES WITH SURCHARGE	
Surcharge for STRUCTURA finishes feet (delivery +2 weeks)		Art Brass	Matt Black Brushed Bronze Oxide
single foot	<b>MGP10</b>	—	83 each

# Tops and 45° bevelled sides on 3 edges for squared compositions

<p><b>Product delivered already assembled.</b> In larger compositions, drawers are packed separately.</p>	Price Groups		
	13	2	3
	Polymeric	Matt White	Matt Colour

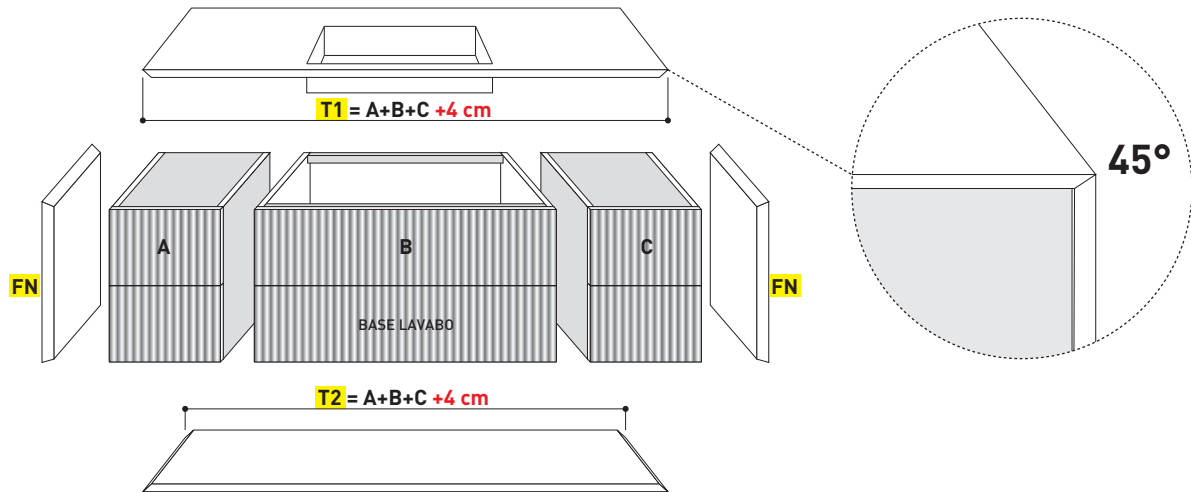

**19 mm Th. Tecnoril or Deimos Tops in sp. 19 mm are on page 19 of General Pricelist**

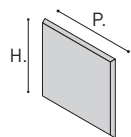

**Side with 45° bevelled edges.**  
RH-LH version.

45° edge



D	H	Code	13	2	3
<b>37,7</b>	28	<b>FN320</b>	-	76	81
	40	<b>FN321</b>	-	97	103
	52	<b>FN322</b>	-	119	127
	64	<b>FN323</b>	-	138	153
<b>53,7</b>	28	<b>FN520</b>	-	95	101
	40	<b>FN521</b>	-	125	131
	52	<b>FN522</b>	-	153	164
	64	<b>FN523</b>	-	181	197

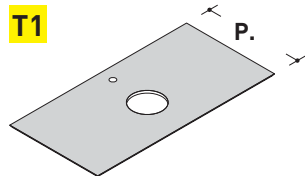

**T1** 45° bevelled upper wooden top, for overstanding or lay-on basins.

45° edge



D	W	Code	13	2	3
<b>37,7</b>	lm.	<b>TL1930</b>	-	223	236
<b>53,7</b>	lm.	<b>TL1950</b>	-	290	305

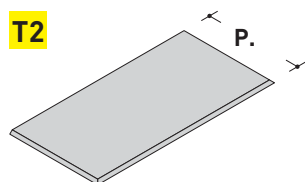

**T2** 45° bevelled lower wooden bottom.

45° edge



D	W	Code	13	2	3
<b>37,7</b>	lm.	<b>PD1930</b>	-	223	236
<b>53,7</b>	lm.	<b>PD1950</b>	-	290	305

# Tops and sides for squared compositions

	Price Groups		
	13	2	3
	Polymeric	Matt White	Matt Colour
	12 mm Th.	12 mm Th.	12 mm Th.

**For integrated or washbasin hole Tops, see specific section on content index on page 385 of General Pricelist.**

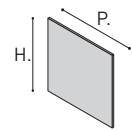
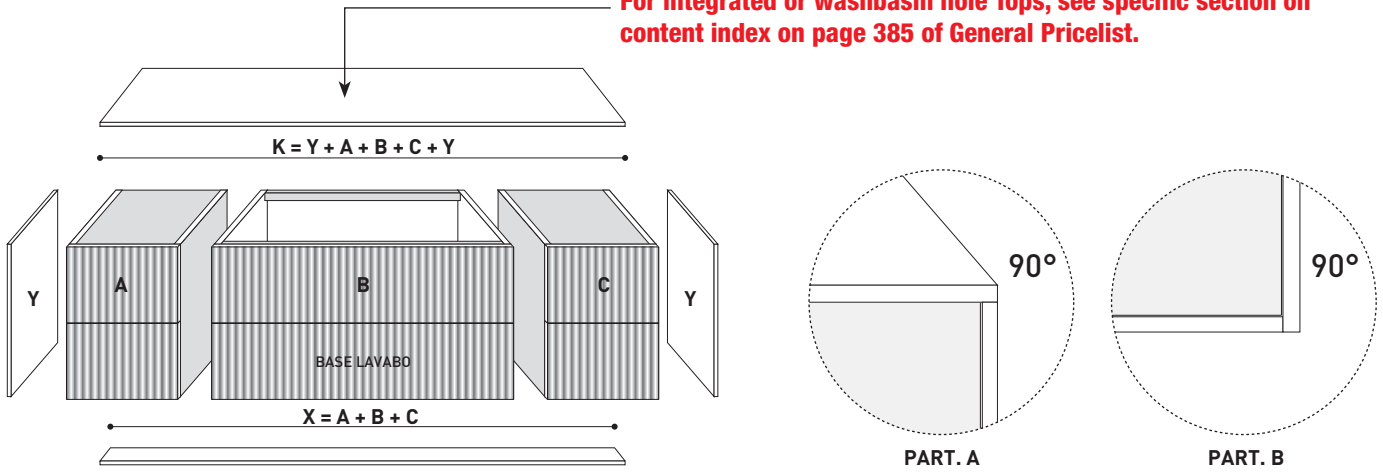

Side to be fixed to the base units, (Y on drawing).

\* For base units with plinth H.4 cm. Not applicable lower closing band.

STRAIGHT edge  
±1,2

D	H	Code	13	2	3
<b>35,2</b>	25,2	FL385	-	53	61
	37,2	FL386	-	57	68
	49,2	FL387	-	72	81
	61,2	FL388	-	81	91
<b>51,2</b>	25,2	FL585	-	61	66
	37,2	FL586	-	64	72
	49,2	FL587	-	80	88
	61,2	FL588	-	88	96
	* 72,2	FL589	-	102	110
	* 84,2	FL590	-	115	124

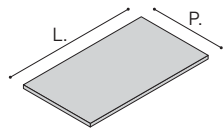

Th. 12 mm upper top, **NOT suitable for overstanding or lay-on basin.**

**For solutions with overstanding washbasin or integrated top, see TOP section.**

STRAIGHT edge  
±1,2

D	W	Code	13	2	3
<b>35,2</b>	lm.	TL102	-	207	244
<b>51,2</b>	lm.	TL104	-	290	354

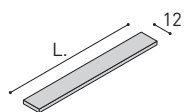

Lower band for framed composition (X on drawing).

STRAIGHT edge  
±1,2

D	W	Code	13	2	3
<b>12</b>	lm.	PL1212	-	53	61

# Wall-hung washbasin units

stonewood®

H. 24 cm

	Price Groups		
	13	2	3
	Polymeric	Matt White	Matt Colour

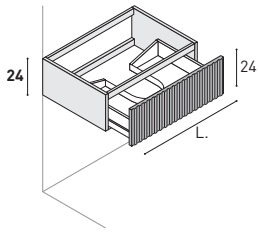

Washbasin unit 1 jumbo metal drawer.

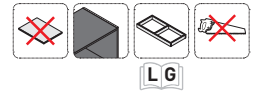

D	W	Code	13	2	3
35	60	<b>BL030C</b>	317	334	346
	70	<b>BL061C</b>	336	354	367
	80	<b>BL031C</b>	346	363	378
	90	<b>BL032C</b>	366	384	399
	100	<b>BL069C</b>	374	393	409
	120	<b>BL033C</b>	412	433	449
51	60	<b>BL070C</b>	349	367	381
	70	<b>BL092C</b>	363	382	396
	80	<b>BL071C</b>	378	398	412
	90	<b>BL072C</b>	396	416	433
	100	<b>BL089C</b>	412	433	449
	120	<b>BL073C</b>	451	475	492

# Open base units

Vertigo Model

H. 24 cm

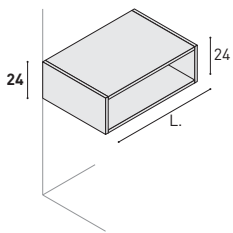

Open base unit 1,8 cm Th.



D	W	Code	13	2	3
35	25	<b>BA23Z1</b>	-	195	216
	35	<b>BA003</b>	-	209	225
	50	<b>BA005</b>	-	251	273
	60	<b>BA006</b>	-	279	305
	70	<b>BA007</b>	-	305	337
51	25	<b>BA25Z1</b>	-	262	285
	35	<b>BA013</b>	-	279	301
	50	<b>BA015</b>	-	333	365
	60	<b>BA016</b>	-	369	407
	70	<b>BA017</b>	-	407	445

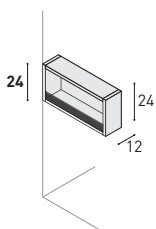

End reversible void element H.24 cm with anti-fall glass.

Element NOT for individual sale.



D	W	Code	13	2	3
35	12	<b>BA23L1</b>	-	150	157
51	12	<b>BA25L1</b>	-	201	215

	Price Groups		
	13	2	3
	Polymeric	Matt White	Matt Colour

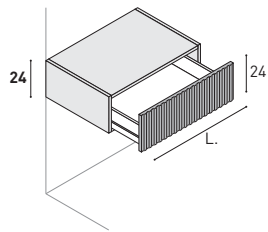

Base unit 1 jumbo metal drawer.

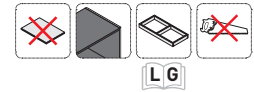

D	W	Code	13	2	3
<b>35</b>	35	<b>BA047C</b>	225	237	246
	50	<b>BA051C</b>	244	257	266
	60	<b>BA030C</b>	258	271	282
	70	<b>BA061C</b>	272	286	297
	80	<b>BA031C</b>	286	301	313
	90	<b>BA032C</b>	301	316	328
	100	<b>BA069C</b>	315	332	344
	120	<b>BA033C</b>	351	369	383
<b>51</b>	35	<b>BA067C</b>	256	269	279
	50	<b>BA082C</b>	279	293	304
	60	<b>BA070C</b>	294	310	322
	70	<b>BA092C</b>	313	329	341
	80	<b>BA071C</b>	330	347	360
	90	<b>BA072C</b>	349	367	381
	100	<b>BA089C</b>	366	384	399
	120	<b>BA073C</b>	396	416	433

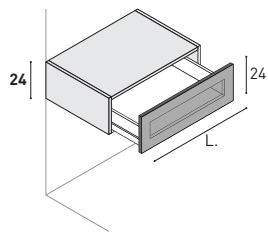

Base unit 1 jumbo metal drawer with black aluminium frame + Stop-sol glass.

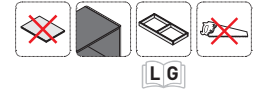

D	W	Code	13	2	3
<b>35</b>	35	<b>BV047C</b>	359	378	392
	50	<b>BV051C</b>	379	399	413
	70	<b>BV061C</b>	413	434	450
<b>51</b>	35	<b>BV067C</b>	379	399	413
	50	<b>BV082C</b>	402	423	438
	70	<b>BV092C</b>	442	465	482

# Wall-hung washbasin units

stonewood®

H. **36** cm

	Price Groups		
	13	2	3
	Polymeric	Matt White	Matt Colour

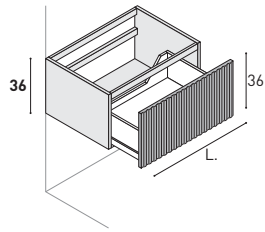

Washbasin unit 1 jumbo metal drawer.



D	W	Code	13	2	3
35	60	<b>BL616C</b>	383	403	418
	70	<b>BL628C</b>	402	423	438
	80	<b>BL617C</b>	416	437	455
	90	<b>BL618C</b>	440	462	480
	100	<b>BL629C</b>	454	477	495
	120	<b>BL619C</b>	482	506	526
51	60	<b>BL1616C</b>	416	437	455
	70	<b>BL1628C</b>	435	457	475
	80	<b>BL1617C</b>	449	472	490
	90	<b>BL1618C</b>	468	492	511
	100	<b>BL1629C</b>	487	512	531
	120	<b>BL1619C</b>	525	552	572

# Open base units

Vertigo Model

H. **36** cm

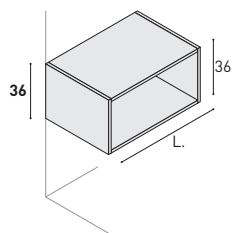

Open base unit 1,8 cm Th.



D	W	Code	13	2	3
35	25	<b>BA612</b>	-	229	247
	35	<b>BA613</b>	-	257	279
	50	<b>BA615</b>	-	305	333
	60	<b>BA33Z4</b>	-	350	391
	70	<b>BA33Z5</b>	-	394	454
	51	25	<b>BA1612</b>	-	301
35		<b>BA1613</b>	-	343	376
50		<b>BA1615</b>	-	396	439
60		<b>BA35Z4</b>	-	449	509
70		<b>BA35Z5</b>	-	504	576

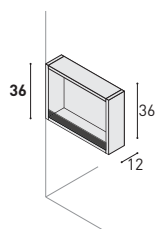

End reversible void element H.36 cm with anti-fall glass.

Element NOT for individual sale.



D	W	Code	13	2	3
35	12	<b>BA33L1</b>	-	152	161
51	12	<b>BA35L1</b>	-	205	219



	Price Groups		
	13	2	3
	Polymeric	Matt White	Matt Colour

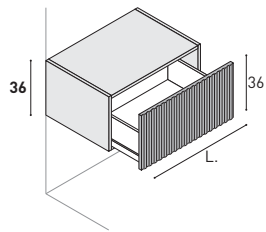

Base unit 1 jumbo metal drawer.

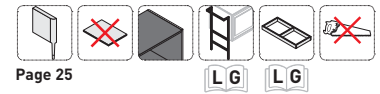

D	W	Code	13	2	3
<b>35</b>	35	<b>BA606C</b>	272	286	297
	50	<b>BA607C</b>	297	313	325
	60	<b>BA616C</b>	315	332	344
	70	<b>BA608C</b>	333	350	363
	80	<b>BA617C</b>	349	367	381
	90	<b>BA618C</b>	366	384	399
	100	<b>BA609C</b>	383	403	418
	120	<b>BA619C</b>	416	437	455
<b>51</b>	35	<b>BA1606C</b>	296	312	324
	50	<b>BA1607C</b>	324	340	354
	60	<b>BA1616C</b>	343	360	373
	70	<b>BA1608C</b>	365	383	398
	80	<b>BA1617C</b>	381	401	416
	90	<b>BA1618C</b>	400	421	436
	100	<b>BA1609C</b>	418	439	457
	120	<b>BA1619C</b>	454	477	495

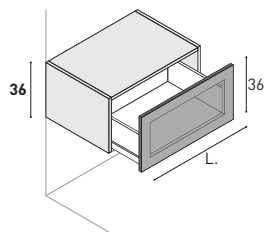

Base unit 1 jumbo metal drawer with black aluminium frame + Stop-sol glass.

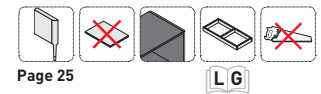

D	W	Code	13	2	3
<b>35</b>	35	<b>BV606C</b>	374	393	409
	50	<b>BV607C</b>	398	418	434
	70	<b>BV608C</b>	434	456	473
<b>51</b>	35	<b>BV1606C</b>	396	416	433
	50	<b>BV1607C</b>	425	447	464
	70	<b>BV1608C</b>	462	486	504

RH as drawer

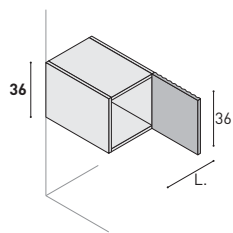

Base unit 1 door.  
RH-LH version.



D	W	Code	13	2	3
<b>35</b>	35	<b>BA600</b>	171	180	186
<b>51</b>	35	<b>BA1600</b>	193	203	211

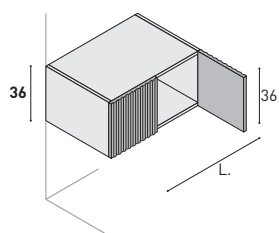

Base unit 2 doors.



D	W	Code	13	2	3
<b>35</b>	70	<b>BA601</b>	263	277	288
<b>51</b>	70	<b>BA1601</b>	292	307	318

	Price Groups		
	13	2	3
	Polymeric	Matt White	Matt Colour

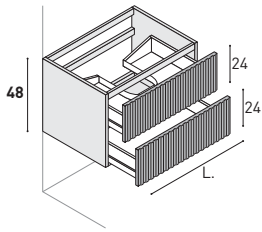

### Washbasin unit 2 jumbo metal drawers.

Modular, to be used only in combination with other base units.

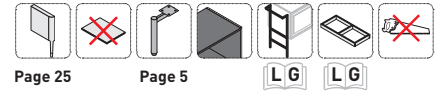

D	W	Code	13	2	3
35	60	<b>BL1060C</b>	502	527	548
	70	<b>BL1066C</b>	530	557	578
	80	<b>BL1061C</b>	554	582	604
	90	<b>BL1062C</b>	577	607	630
	100	<b>BL1073C</b>	601	632	656
	120	<b>BL1063C</b>	643	676	701
51	60	<b>BL1462C</b>	548	576	598
	70	<b>BL1466C</b>	577	607	630
	80	<b>BL1467C</b>	601	632	656
	90	<b>BL1472C</b>	624	656	681
	100	<b>BL1473C</b>	668	702	729
	120	<b>BL1482C</b>	733	770	799

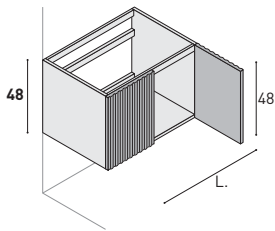

### Washbasin unit 2 doors.

Modular, to be used only in combination with other base units.

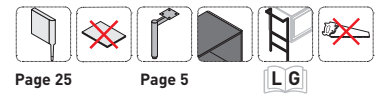

D	W	Code	13	2	3
35	70	<b>BL1065</b>	341	359	372
51	70	<b>BL1465</b>	388	407	423

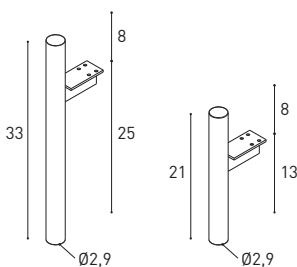

### Vertigo foot.

NON-bearing element, always fix units and columns to the wall.

H	Code	Matt Black Price	Art Brass Brushed Bronze Oxide Price
21	<b>PI150</b>	66 each	105 each
33	<b>PI160</b>	72 each	110 each

			Price Groups		
			13	2	3
			Polymeric	Matt White	Matt Colour

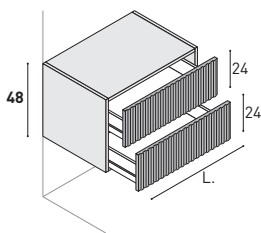

Base unit 2 jumbo metal drawers.

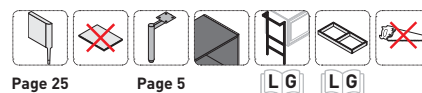

D	W	Code	13	2	3
<b>35</b>	35	BA1047C	392	412	428
	50	BA1051C	423	445	461
	60	BA1066C	448	471	489
	70	BA1061C	473	498	516
	80	BA1067C	500	525	545
	90	BA1068C	524	550	571
	100	BA1071C	549	577	599
	120	BA1069C	593	623	647
<b>51</b>	35	BA1447C	425	447	464
	50	BA1451C	459	482	501
	60	BA1466C	484	509	528
	70	BA1461C	517	544	565
	80	BA1467C	543	570	592
	90	BA1468C	569	598	621
	100	BA1471C	597	627	651
	120	BA1469C	645	678	703

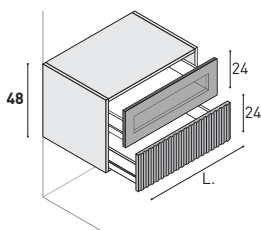

Base unit 1 upper jumbo metal drawer with black aluminium frame + Stop-sol glass, 1 lower jumbo metal drawer.



D	W	Code	13	2	3
<b>35</b>	35	BV1010C	490	515	535
	50	BV1011C	517	544	565
	70	BV1012C	572	601	624
<b>51</b>	35	BV1020C	517	544	565
	50	BV1021C	549	577	599
	70	BV1022C	610	641	665

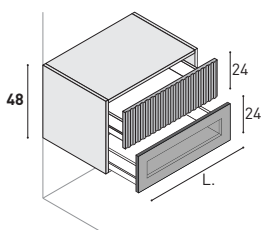

Base unit 1 upper jumbo metal drawer, 1 lower jumbo metal drawer with black aluminium frame + Stop-sol glass.



D	W	Code	13	2	3
<b>35</b>	35	BV1030C	490	515	535
	50	BV1031C	517	544	565
	70	BV1032C	572	601	624
<b>51</b>	35	BV1040C	517	544	565
	50	BV1041C	548	576	598
	70	BV1042C	610	641	665

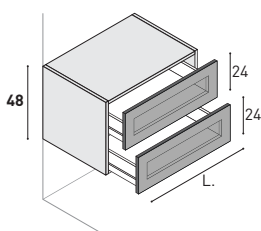

Base unit 2 jumbo metal drawers with black aluminium frame + Stop-sol glass.



D	W	Code	13	2	3
<b>35</b>	35	BV1047C	605	636	660
	50	BV1051C	646	679	704
	70	BV1061C	693	729	756
<b>51</b>	35	BV1447C	638	670	697
	50	BV1451C	679	713	741
	70	BV1461C	744	781	811

	Price Groups		
	13	2	3
	Polymeric	Matt White	Matt Colour

RH as drawer

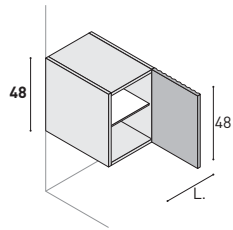

### Base unit 1 door, 1 glass shelf.

RH-LH version.

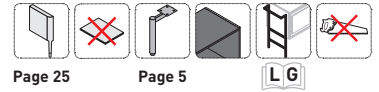

D	W	Code	13	2	3
<b>21</b>	35	<b>BA1031</b>	182	192	198
<b>35</b>	35	<b>BA1040</b>	201	212	219
<b>51</b>	35	<b>BA1440</b>	228	240	249

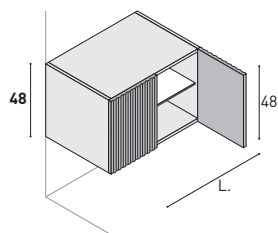

### Base unit 2 doors, 1 glass shelf.

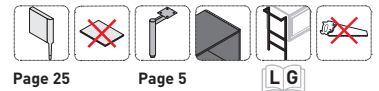

D	W	Code	13	2	3
<b>35</b>	70	<b>BA1060</b>	421	443	459
<b>51</b>	70	<b>BA1460</b>	349	367	381

RH as drawer

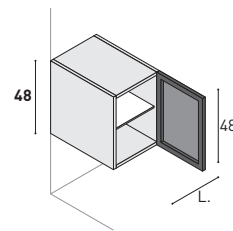

### Base unit 1 door with black aluminium frame + Stop-sol glass, 1 glass shelf.

RH-LH version.

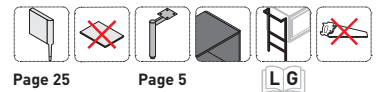

D	W	Code	13	2	3
<b>21</b>	35	<b>BV1031</b>	295	311	323
<b>35</b>	35	<b>BV1040</b>	314	330	343
<b>51</b>	35	<b>BV1440</b>	341	359	372

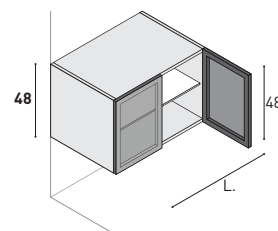

### Base unit 2 doors with black aluminium frame + Stop-sol glass, 1 glass shelf.

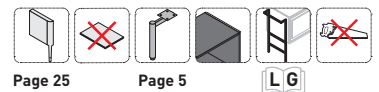

D	W	Code	13	2	3
<b>35</b>	70	<b>BV1060</b>	545	572	594
<b>51</b>	70	<b>BV1460</b>	582	612	635

	Price Groups		
	13	2	3
	Polymeric	Matt White	Matt Colour

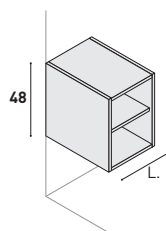

### Open base unit 1,8 cm Th, 1 wooden shelf.

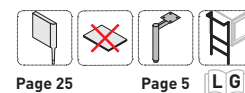

D	W	Code	13	2	3
<b>21</b>	25	<b>BA1020</b>	-	305	326
	35	<b>BA1021</b>	-	354	385
	50	<b>BA1022</b>	-	428	466
	60	<b>BA1023</b>	-	499	544
	70	<b>BA1024</b>	-	572	624
<b>35</b>	25	<b>BA1012</b>	-	305	326
	35	<b>BA1013</b>	-	354	385
	50	<b>BA1015</b>	-	428	466
	60	<b>BA43Z4</b>	-	499	544
	70	<b>BA43Z5</b>	-	572	624
<b>51</b>	25	<b>BA1412</b>	-	412	444
	35	<b>BA1413</b>	-	479	514
	50	<b>BA1415</b>	-	579	626
	60	<b>BA45Z4</b>	-	670	722
	70	<b>BA45Z5</b>	-	744	824

RH as drawer

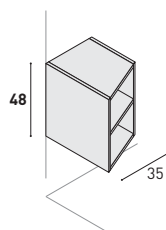

### Open base unit, for changing depths, 1 wooden shelf

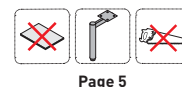

D	W	Code	13	2	3
<b>35/21</b>	35	<b>BTG4N5</b>	-	270	288
<b>51/35</b>	35	<b>BTG4N3</b>	-	297	315
<b>67/35</b>	35	<b>BTG4N2</b>	-	328	350
<b>67/51</b>	35	<b>BTG4N4</b>	-	346	368

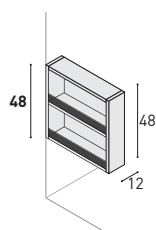

### End reversible void element H.48 cm with anti-fall glass.

Element NOT for individual sale.



D	W	Code	13	2	3
<b>35</b>	12	<b>BA43L1</b>	-	205	219
<b>51</b>	12	<b>BA45L1</b>	-	251	274

# Wall-hung washbasin units

**Wall-hung element.**  
**On request supplied with plinth H.4 cm.**  
**Without surcharge.**

Price Groups

13	2	3
Polymeric	Matt White	Matt Colour

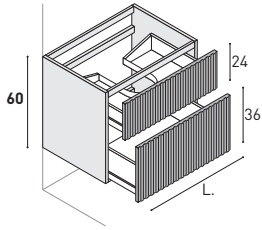

**Washbasin unit 2 jumbo metal drawers.**



D	W	Code	13	2	3
35	60	<b>BL561C</b>	563	591	613
	70	<b>BL566C</b>	591	621	645
	80	<b>BL562C</b>	615	646	671
	90	<b>BL563C</b>	643	676	701
	100	<b>BL567C</b>	671	706	732
	120	<b>BL564C</b>	719	755	784
51	60	<b>BL960C</b>	610	641	665
	70	<b>BL966C</b>	643	676	701
	80	<b>BL961C</b>	667	701	728
	90	<b>BL962C</b>	700	735	764
	100	<b>BL967C</b>	723	759	789
	120	<b>BL964C</b>	780	820	851

## Vertigo foot.

**NON-bearing element, always fix units and columns to the wall.**

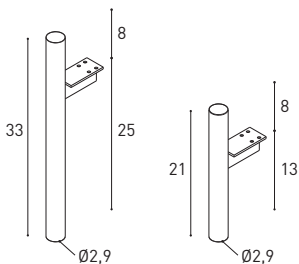

H	Code	Matt Black Price	Art Brass Brushed Bronze Oxide Price
21	<b>PI150</b>	66 each	105 each
33	<b>PI160</b>	72 each	110 each

Wall-hung element.  
On request supplied with plinth H.4 cm.  
Without surcharge.

Price Groups

13	2	3
Polymeric	Matt White	Matt Colour

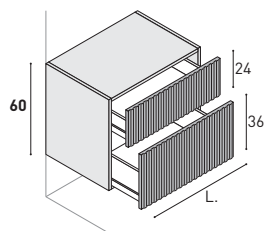

Base unit 2 jumbo metal drawers.



D	W	Code	13	2	3
35	35	BA556C	439	461	479
	50	BA557C	478	502	522
	60	BA551C	505	531	552
	70	BA558C	534	561	582
	80	BA552C	563	591	613
	90	BA553C	590	620	644
	100	BA559C	618	649	674
	120	BA554C	669	703	730
51	35	BA956C	473	498	516
	50	BA957C	515	542	563
	60	BA951C	544	571	593
	70	BA958C	574	603	625
	80	BA952C	602	633	657
	90	BA953C	633	665	690
	100	BA959C	666	700	726
	120	BA954C	722	758	788

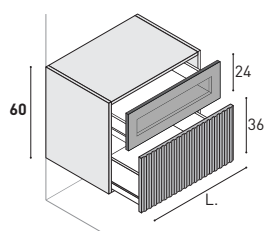

Base unit 1 upper jumbo metal drawer with black aluminium frame + Stop-sol glass, 1 lower jumbo metal drawer.



D	W	Code	13	2	3
35	35	BV610C	601	632	656
	50	BV611C	637	669	696
	70	BV612C	693	729	756
51	35	BV620C	636	668	695
	50	BV621C	679	713	741
	70	BV622C	744	781	811

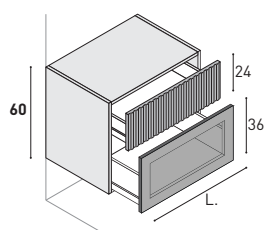

Base unit 1 upper jumbo metal drawer, 1 lower jumbo metal drawer with black aluminium frame + Stop-sol glass.



D	W	Code	13	2	3
35	35	BV630C	596	626	649
	50	BV631C	633	665	690
	70	BV632C	688	723	751
51	35	BV640C	633	665	690
	50	BV641C	675	709	736
	70	BV642C	740	777	807

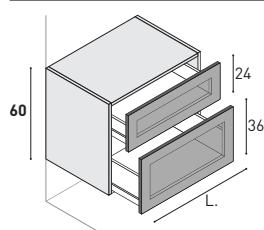

Base unit 2 jumbo metal drawers with black aluminium frame + Stop-sol glass.



D	W	Code	13	2	3
35	35	BV556C	721	757	786
	50	BV557C	763	801	832
	70	BV558C	822	864	897
51	35	BV956C	762	800	831
	50	BV957C	803	844	876
	70	BV958C	868	912	948

<p><b>Wall-hung element.</b>                  On request supplied with plinth H.4 cm.                  Without surcharge.</p>	Price Groups		
	13	2	3
	Polymeric	Matt White	Matt Colour

RH as drawer

**Base unit 1 metal drawer, 1 door.**

RH-LH version.

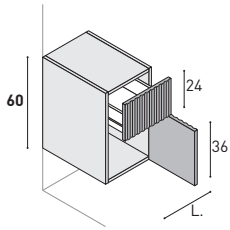

D	W	Code	13	2	3
<b>35</b>	35	<b>BA544C</b>	338	356	369
<b>51</b>	35	<b>BA944C</b>	372	391	406

RH as drawer

**Base unit 1 metal drawer with black aluminium frame + Stop-sol glass, 1 door.**

RH-LH version.

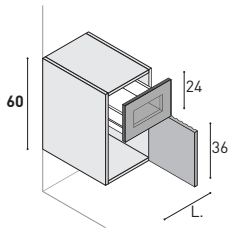

D	W	Code	13	2	3
<b>35</b>	35	<b>BV544C</b>	438	460	478
<b>51</b>	35	<b>BV944C</b>	471	495	514



**Wall-hung element.**  
**On request supplied with plinth H.4 cm.**  
**Without surcharge.**

Price Groups

	13	2	3
	Polymeric	Matt White	Matt Colour

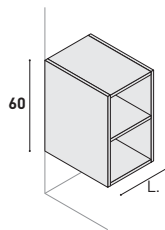

**Open base unit 1,8 cm Th, 1 wooden shelf.**

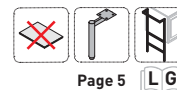

D	W	Code	13	2	3
<b>21</b>	25	<b>BG235</b>	-	230	240
	35	<b>BG240</b>	-	252	262
<b>35</b>	25	<b>BG535</b>	-	240	251
	35	<b>BG540</b>	-	261	275
<b>51</b>	25	<b>BG935</b>	-	284	300
	35	<b>BG940</b>	-	311	328

RH as drawer

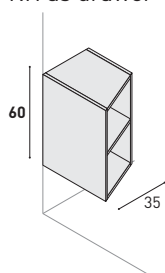

**Open base unit, for changing depths, 1 wooden shelf.**

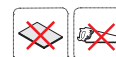

D	W	Code	13	2	3
<b>51/35</b>	35	<b>BTG6N3</b>	-	304	322

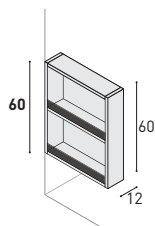

**End reversible void element H.60 cm with anti-fall glass.**

Element NOT for individual sale.



D	W	Code	13	2	3
<b>35</b>	12	<b>BA63L1</b>	-	236	252
<b>51</b>	12	<b>BA65L1</b>	-	290	315

**Wall-hung element.**  
On request supplied with plinth H.4 cm.  
Without surcharge.

Price Groups

13

2

3

Polymeric

Matt  
White

Matt  
Colour

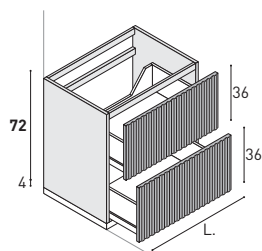

### Washbasin unit 2 jumbo metal drawers.

Recommended for sit-on, recessed and ovetop washbasins.

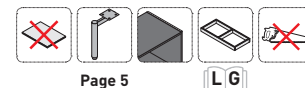

D	W	Code	13	2	3
<b>35</b>	60	<b>BL73D4</b>	637	669	696
	70	<b>BL73D5</b>	670	704	731
	80	<b>BL73D6</b>	698	733	762
	90	<b>BL73D7</b>	730	767	796
	100	<b>BL73D8</b>	763	801	832
	120	<b>BL73D9</b>	822	864	897
<b>51</b>	60	<b>BL75D4</b>	698	733	762
	70	<b>BL75D5</b>	734	772	801
	80	<b>BL75D6</b>	763	801	832
	90	<b>BL75D7</b>	795	835	866
	100	<b>BL75D8</b>	827	868	901
	120	<b>BL75D9</b>	891	937	972

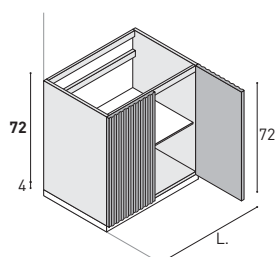

### Washbasin unit 2 doors, 1 glass shelf.

Recommended for sit-on, recessed and ovetop washbasins.



D	W	Code	13	2	3
<b>35</b>	• 70	<b>BL73M5</b>	410	431	447
<b>51</b>	• 70	<b>BL75M5</b>	471	495	514

## Open base units

Vertigo System

# H. 72+4 cm

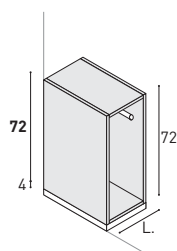

### Base unit with pullout towel holder.



D	W	Code	13	2	3
<b>35</b>	from 20 to 30	<b>BA73G1</b>	-	241	257
<b>51</b>	from 20 to 30	<b>BA75G1</b>	-	311	332

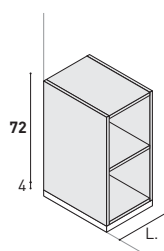

### Open base unit 1,8 cm Th, 1 wooden shelf.



D	W	Code	13	2	3
<b>35</b>	25	<b>BG73N1</b>	-	222	262
	35	<b>BG73N2</b>	-	263	305
<b>51</b>	25	<b>BG75N1</b>	-	282	301
	35	<b>BG75N2</b>	-	314	330

**Wall-hung element.  
On request supplied with plinth H.4 cm.  
Without surcharge.**

Price Groups		
13	2	3
Polymeric	Matt White	Matt Colour

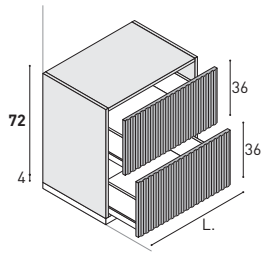

**Base unit 2 jumbo metal drawers.**

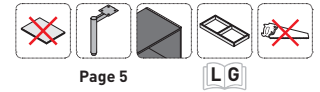

D	W	Code	13	2	3
<b>35</b>	35	<b>BA73D2</b>	467	491	510
	50	<b>BA73D3</b>	513	539	559
	60	<b>BA73D4</b>	541	568	590
	70	<b>BA73D5</b>	572	601	624
	80	<b>BA73D6</b>	605	636	660
	90	<b>BA73D7</b>	637	669	696
	100	<b>BA73D8</b>	665	699	725
	120	<b>BA73D9</b>	725	762	791
	<b>51</b>	35	<b>BA75D2</b>	509	535
50		<b>BA75D3</b>	555	583	605
60		<b>BA75D4</b>	587	616	640
70		<b>BA75D5</b>	624	656	681
80		<b>BA75D6</b>	656	689	715
90		<b>BA75D7</b>	688	723	751
100		<b>BA75D8</b>	721	757	786
120		<b>BA75D9</b>	786	825	857

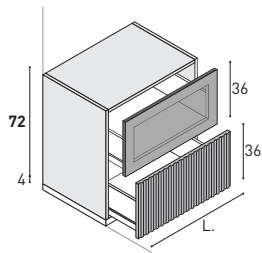

**Base unit 1 upper jumbo metal drawer with black aluminium frame + Stop-sol glass, 1 lower jumbo metal drawer.**

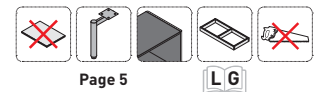

D	W	Code	13	2	3
<b>35</b>	35	<b>BV710C</b>	591	621	645
	50	<b>BV711C</b>	637	669	696
	70	<b>BV712C</b>	702	737	766
<b>51</b>	35	<b>BV720C</b>	629	660	686
	50	<b>BV721C</b>	679	713	741
	70	<b>BV722C</b>	753	791	821

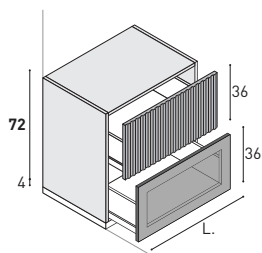

**Base unit 1 upper jumbo metal drawer, 1 lower jumbo metal drawer with black aluminium frame + Stop-sol glass.**



D	W	Code	13	2	3
<b>35</b>	35	<b>BV730C</b>	591	621	645
	50	<b>BV731C</b>	637	669	696
	70	<b>BV732C</b>	702	737	766
<b>51</b>	35	<b>BV740C</b>	629	660	686
	50	<b>BV741C</b>	679	713	741
	70	<b>BV742C</b>	753	791	821

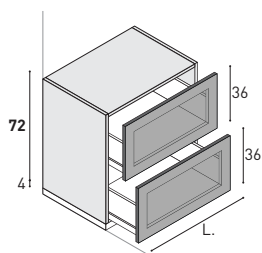

**Base unit 2 jumbo metal drawers with black aluminium frame + Stop-sol glass.**

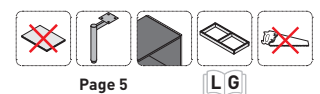

D	W	Code	13	2	3
<b>35</b>	35	<b>BV73D2</b>	711	747	776
	50	<b>BV73D3</b>	757	796	825
	70	<b>BV73D5</b>	827	868	901
<b>51</b>	35	<b>BV75D2</b>	753	791	821
	50	<b>BV75D3</b>	792	832	864
	70	<b>BV75D5</b>	876	920	955

	Price Groups		
	13	2	3
	Polymeric	Matt White	Matt Colour

RH as drawer

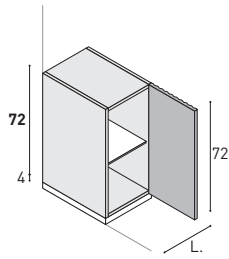

### Base unit 1 door, 1 glass shelf.

RH-LH version.

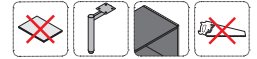

Page 5

D	W	Code	13	2	3
35	35	BA73N2	250	263	273
51	35	BA75N2	294	310	322

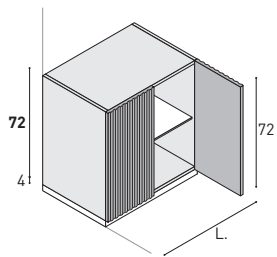

### Base unit 2 doors, 1 glass shelf.

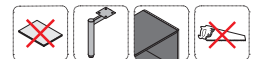

Page 5

D	W	Code	13	2	3
35	70	BA73M5	388	407	423
51	70	BA75M5	438	460	478

RH as drawer

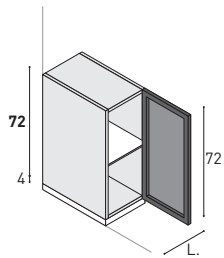

### Base unit 1 door with black aluminium frame + Stop-sol glass, 1 glass shelf.

RH-LH version.



Page 5

D	W	Code	13	2	3
35	35	BV73N2	374	393	409
51	35	BV75N2	416	437	455

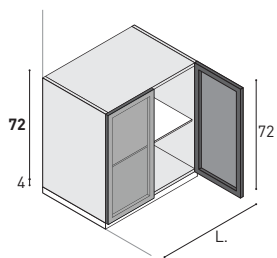

### Base unit 2 doors with black aluminium frame + Stop-sol glass, 1 glass shelf.



Page 5

D	W	Code	13	2	3
35	70	BV73M5	642	675	700
51	70	BV75M5	693	729	756

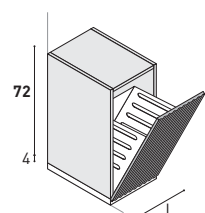

### Base unit with 1 flap door, 1 laundry basket in anthracite finish metal sheet.

**Push-pull opening excluded**

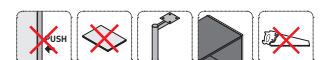

Page 5

D	W	Code	13	2	3
51	35	BA75R2	426	448	465

	Price Groups		
	13	2	3
	Polymeric	Matt White	Matt Colour

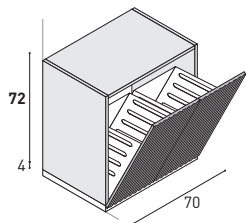

Base unit with 2 flap doors, 2 laundry baskets in anthracite finish metal sheet.

**Push-pull opening excluded**

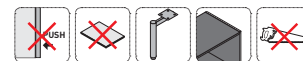

Page 5

D	W	Code	13	2	3
51	70	BA75E5	790	830	862

# Floor-standing washbasin units

**Element with H.4 cm plinth**  
**On request supplied suspended.**  
**Without surcharge.**

Price Groups		
13	2	3
Polymeric	Matt White	Matt Colour

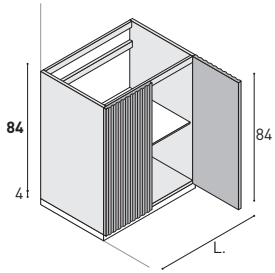

**Washbasin unit 2 doors, 1 glass shelf.**



D	W	Code	13	2	3
<b>51</b>	70	<b>BL85M5</b>	558	587	609

	Price Groups		
	13	2	3
	Polymeric	Matt White	Matt Colour

### Base unit with pullout towel holder.

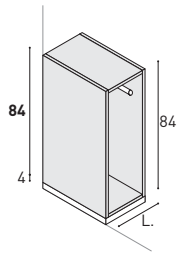

D	W	Code	13	2	3
<b>35</b>	from 20 to 30	<b>BA83G1</b>	-	256	273
<b>51</b>	from 20 to 30	<b>BA85G1</b>	-	330	352

### Open base unit 1,8 cm Th, 2 wooden shelves.

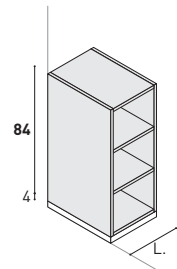

D	W	Code	13	2	3
<b>35</b>	25	<b>BG83N1</b>	-	258	273
	35	<b>BG83N2</b>	-	290	310
<b>51</b>	25	<b>BG85N1</b>	-	307	325
	35	<b>BG85N2</b>	-	344	367

RH as drawer

### Base unit 1 door, 2 glass shelves.

RH-LH version.

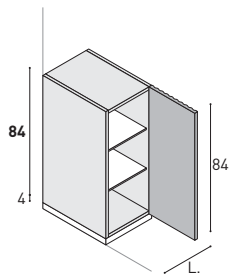

D	W	Code	13	2	3
<b>35</b>	35	<b>BA83N2</b>	284	299	311
<b>51</b>	35	<b>BA85N2</b>	332	349	362

### Base unit 2 doors, 1 glass shelf.

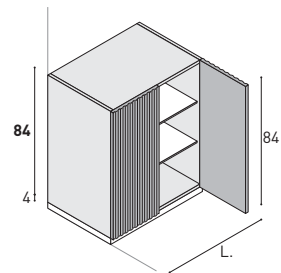

D	W	Code	13	2	3
<b>35</b>	70	<b>BA83M5</b>	440	462	480
<b>51</b>	70	<b>BA85M5</b>	501	526	546

RH as drawer

### Base unit 1 door with black aluminium frame + Stop-sol glass, 2 glass shelves.

RH-LH version.

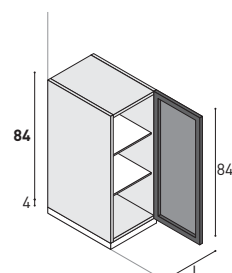

D	W	Code	13	2	3
<b>35</b>	35	<b>BV83N2</b>	411	432	448
<b>51</b>	35	<b>BV85N2</b>	453	476	493

# Floor standing base units

	Price Groups		
	13	2	3
	Polymeric	Matt White	Matt Colour

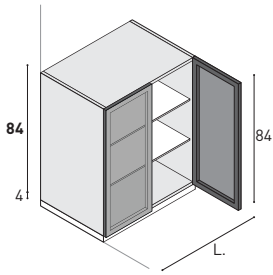

Base unit 2 doors with black aluminium frame + Stop-sol glass, 2 glass shelves.



D	W	Code	13	2	3
35	70	BV83M5	698	733	762
51	70	BV85M5	753	791	821

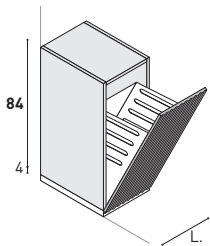

Base unit with 1 flap door, 1 laundry basket in anthracite finish metal sheet  
**Push-pull opening excluded**



D	W	Code	13	2	3
51	35	BA85R2	480	504	524

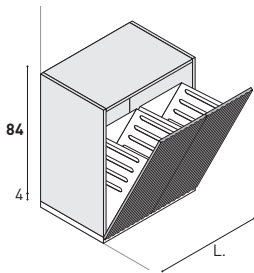

Base unit with 2 flap doors, 2 laundry baskets in anthracite finish metal sheet.  
**Push-pull opening excluded**



D	W	Code	13	2	3
51	70	BA85E5	822	864	897



	Price Groups		
	13	2	3
	Polymeric	Matt White	Matt Colour

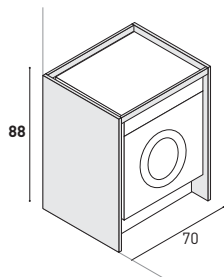

Base unit for washing machine without doors, without plinth.  
Internal finish in Anthracite



D	W	Code	13	2	3
<b>49</b>	70	<b>BG85M5</b>	394	418	437

Useful interior dimensions: W.65 - D.45,5 - H.87

<b>65</b>	70	<b>BG87M5</b>	438	465	483
-----------	----	---------------	-----	-----	-----

Useful interior dimensions: W.65 - D.61,5 - H.87

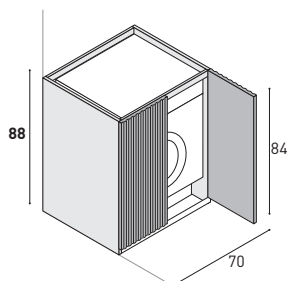

Base unit 2 doors for washing machine, pull-out plinth.

**Important: In case of washer-dryer, the appliance must always work with open doors**



D	W	Code	13	2	3
<b>51</b>	70	<b>BP85M5</b>	526	553	575

Useful interior dimensions: W.61 - D.45,5 - H.87

<b>67</b>	70	<b>BP87M5</b>	582	612	635
-----------	----	---------------	-----	-----	-----

Useful interior dimensions: W.61 - D.61,5 - H.87

<b>Wall units COMBO and Complementary elements from page 56</b>	Price Groups		
	13	2	3
	Polymeric	Matt White	Matt Colour

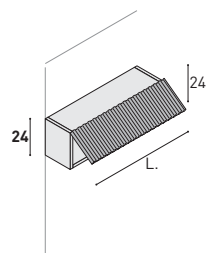

### Wall unit 1 VASISTAS opening door.

Wall unit 1 VASISTAS opening door.



D	W	Code	13	2	3
<b>21</b>	50	<b>PE22W3</b>	279	293	304
	60	<b>PE643</b>	296	312	324
	70	<b>PE644</b>	314	330	343
	80	<b>PE645</b>	336	354	367
	90	<b>PE646</b>	352	370	384
	100	<b>PE647</b>	377	396	411
	120	<b>PE648</b>	409	429	446

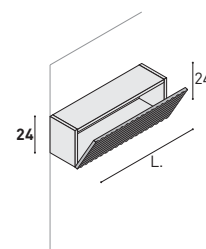

### Wall unit 1 FLAP door

W.100-120 with central division.



D	W	Code	13	2	3
<b>21</b>	60	<b>PE653</b>	307	323	336
	70	<b>PE654</b>	325	341	355
	80	<b>PE655</b>	347	365	379
	90	<b>PE656</b>	365	383	398
	100	<b>PE657</b>	388	407	423
	120	<b>PE658</b>	420	442	458

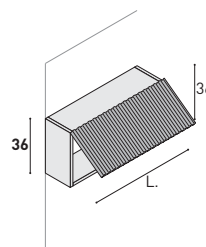

### Wall unit 1 VASISTAS opening door.

W.100-120 with central division.



D	W	Code	13	2	3
<b>21</b>	50	<b>PE32W3</b>	303	318	330
	60	<b>PE32W4</b>	321	337	350
	70	<b>PE32W5</b>	344	361	376
	80	<b>PE32W6</b>	368	387	402
	90	<b>PE32W7</b>	388	407	423
	100	<b>PE640</b>	418	439	457
	120	<b>PE32W9</b>	456	479	498

**Wall units COMBO  
and Complementary elements  
from page 56**

Price Groups

13	2	3
Polymeric	Matt White	Matt Colour

RH as drawer

**Wall unit 1 door, 1 glass shelf.**

Versione DX-SX.

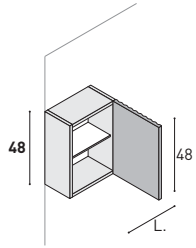

D	W	Code	13	2	3
21	35	PE42N2	237	249	259

**Wall unit 2 doors, 1 glass shelf.**

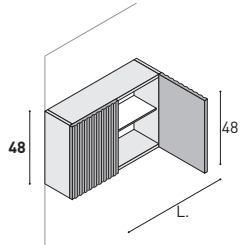

D	W	Code	13	2	3
21	70	PE42M5	351	369	383

RH as drawer

**Wall unit 1 door with black aluminium frame + Stop-sol glass, 1 glass shelf.**

RH-LH version.



Page 51

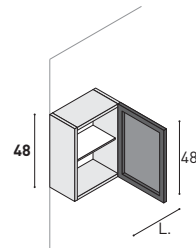

D	W	Code	13	2	3
21	35	PV212	328	337	348

**Wall unit 2 doors with black aluminium frame + Stop-sol glass, 1 glass shelf.**



Page 51

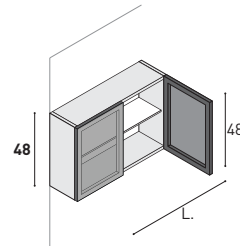

D	W	Code	13	2	3
21	70	PV230	600	623	634

**Wall units COMBO  
and Complementary elements  
from page 56**

Price Groups

**13**

**2**

**3**

**Polymeric**

**Matt  
White**

**Matt  
Colour**

RH as drawer

**Wall unit 1 door, 2 glass shelves.**

RH-LH version.

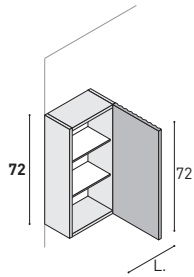

D	W	Code	13	2	3
<b>21</b>	35	<b>PE72N2</b>	286	301	313
<b>35</b>	35	<b>PE73N2</b>	347	365	379

**Wall unit 2 doors, 2 glass shelves.**

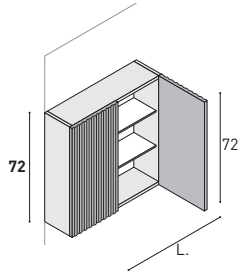
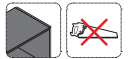

D	W	Code	13	2	3
<b>21</b>	70	<b>PE72M5</b>	432	454	471
<b>35</b>	70	<b>PE73M5</b>	522	548	569

RH as drawer

**Wall unit 1 door with black aluminium frame + Stop-sol glass, 2 glass shelves.**

RH-LH version.

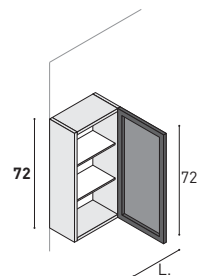

D	W	Code	13	2	3
<b>21</b>	35	<b>PV251</b>	369	381	384
<b>35</b>	35	<b>PV253</b>	423	443	447

**Wall unit 2 doors with black aluminium frame + Stop-sol glass, 2 glass shelves.**

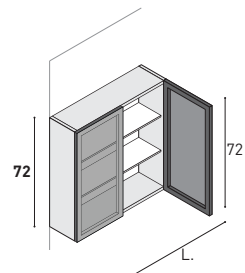
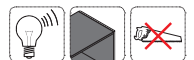

D	W	Code	13	2	3
<b>21</b>	70	<b>PV255</b>	627	647	654
<b>35</b>	70	<b>PV256</b>	713	731	739

**Wall units COMBO  
and Complementary elements  
from page 56**

Price Groups

**13**

**2**

**3**

**Polymeric**

**Matt  
White**

**Matt  
Colour**

RH as drawer

**Wall unit 2 doors, 1 internal fixed division.**

RH-LH version.

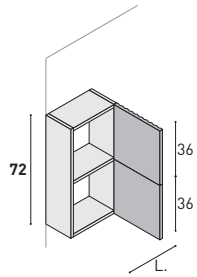

D	W	Code	<b>13</b>	<b>2</b>	<b>3</b>
<b>21</b>	35	<b>PE114</b>	328	345	358
<b>35</b>	35	<b>PE73D1</b>	381	401	416

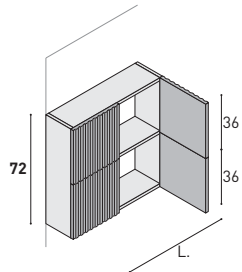

**Wall unit 4 doors, 1 internal fixed division.**



D	W	Code	<b>13</b>	<b>2</b>	<b>3</b>
<b>21</b>	70	<b>PE128</b>	506	532	553
<b>35</b>	70	<b>PE73E5</b>	591	621	645



2 LED lights kit, with sensor (12V - K°4000 - 9,6W/ml)

**MG105** 198 each part

<b>Wall units COMBO and Complementary elements from page 56</b>	Price Groups		
	13	2	3
	Polymeric	Matt White	Matt Colour

RH as drawer

### Wall unit 1 door, 2 glass shelves.

RH-LH version.

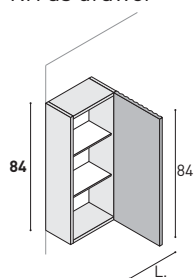

D	W	Code	13	2	3
<b>21</b>	35	<b>PE411</b>	324	335	338
<b>35</b>	35	<b>PE83N2</b>	399	420	435

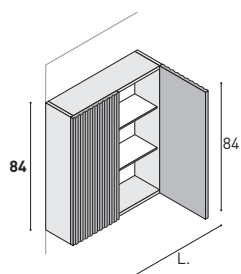

### Wall unit 2 doors, 2 glass shelves.



D	W	Code	13	2	3
<b>21</b>	70	<b>PE425</b>	534	561	582
<b>35</b>	70	<b>PE83M5</b>	608	638	663

RH as drawer

### Wall unit 1 door with black aluminium frame + Stop-sol glass, 2 glass shelves.

RH-LH version.

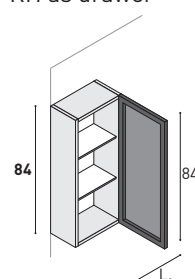

D	W	Code	13	2	3
<b>21</b>	35	<b>PV260</b>	416	443	447
<b>35</b>	35	<b>PV262</b>	488	473	479

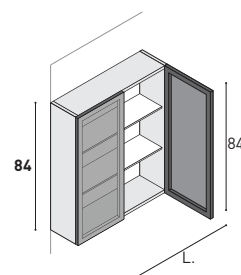

### Wall unit 2 doors with black aluminium frame + Stop-sol glass, 2 glass shelves.



D	W	Code	13	2	3
<b>21</b>	70	<b>PV264</b>	690	713	721
<b>35</b>	70	<b>PV265</b>	740	770	778

<b>Wall units COMBO and Complementary elements from page 56</b>	Price Groups		
	13	2	3
	Polymeric	Matt White	Matt Colour

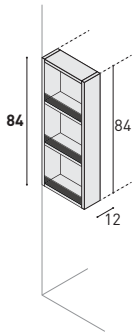

**End reversible void element H.84 cm with anti-fall glass.**  
Element NOT for individual sale.



D	W	Code	13	2	3
35	12	CL83L1	-	359	378



2 LED lights kit, with sensor (12V - K°4000 - 9,6W/ml)

**MG105** 198 each part

**Wall units COMBO  
and Complementary elements  
from page 56**

Price Groups

13

2

3

Polymeric

Matt  
White

Matt  
Colour

RH as drawer

**Wall unit 1 door, 3 glass shelves.**

RH-LH version.

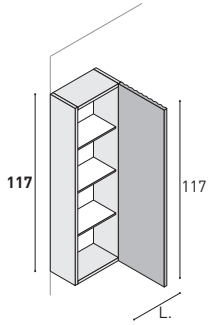

D	W	Code	13	2	3
21	35	PE302	396	416	433
35	35	PE303	467	491	510

**Wall unit 2 doors, 3 glass shelves.**

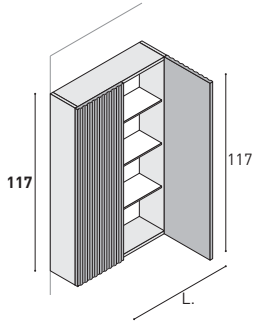

D	W	Code	13	2	3
21	70	PE322	564	592	615
35	70	PE323	666	700	726

RH as drawer

**Wall unit 1 door with black aluminium frame + Stop-sol glass,  
3 glass shelves.**

RH-LH version.

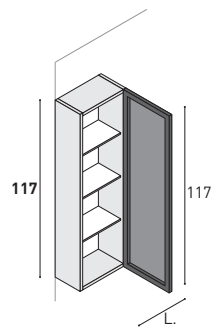

D	W	Code	13	2	3
21	35	PV270	526	556	561
35	35	PV271	586	612	619

**Wall unit 2 doors with black aluminium frame + Stop-sol glass,  
3 glass shelves.**

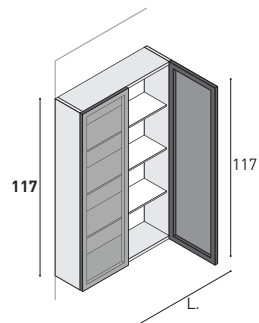

D	W	Code	13	2	3
21	70	PV272	834	871	879
35	70	PV273	888	931	941



Wall units COMBO  
and Complementary elements  
from page 56

Price Groups

13	2	3
Polymeric	Matt White	Matt Colour

H. 177 open wall unit 1,8 cm Th., 3 wooden shelves

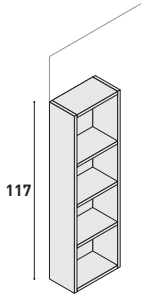

D	W	Code	13	2	3
<b>19</b>	25	<b>PE935</b>	-	213	262
	35	<b>PE936</b>	-	247	305
	C.S. max. width 50 <b>PE937</b>		-	290	357

End reversible void element H.117 cm with anti-fall glass.

Element NOT for individual sale.

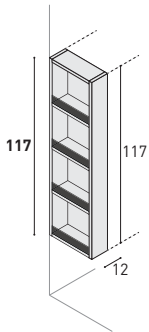

D	W	Code	13	2	3
<b>35</b>	12	<b>CL23L1</b>	-	400	420



2 LED lights kit, with sensor (12V - K°4000 - 9,6W/ml)

**MG105** 198 each part

<b>Door opens with hands. (No Handle - No Push-Pull)</b>  <b>Combinations:</b> <b>Matt White carcass - Polymeric front = price group 2</b> <b>Matt Colour carcass - Polymeric front = price group 3</b>	Price Groups		
	13	2	3
	<b>Polymeric only with lacquered carcass</b>	<b>Matt White</b>	<b>Matt Colour</b>

LH as drawer

### Wall unit 1 door and open compartments

RH-LH version.

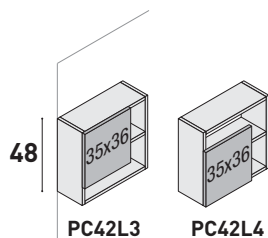

D	W	Code	13	2	3
21	50	PC42L3	-	365	383
	50	PC42L4	-	365	383

LH as drawer

### Wall unit 2 doors and open compartments

RH-LH version.

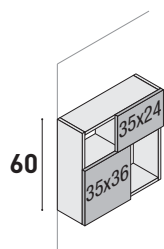

D	W	Code	13	2	3
21	60	PE203A	-	538	566

LH as drawer

### Wall unit 2 doors and open compartments

RH-LH version.

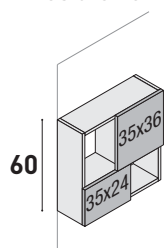

D	W	Code	13	2	3
21	60	PE203B	-	538	566

LH as drawer

### Wall unit 2 doors and open compartments

RH-LH version.

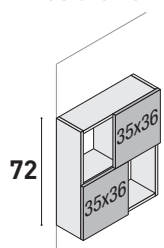

D	W	Code	13	2	3
21	60	PE117	-	564	592

LH as drawer

### Wall unit 1 door and open compartments, 1 wooden shelf

RH-LH version.

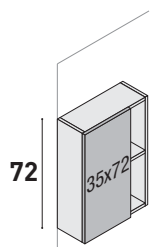

D	W	Code	13	2	3
21	50	PC72N3	-	437	459

LH as drawer

### Wall unit 1 door with black aluminium frame and open compartments, 1 wooden shelf.

RH-LH version.

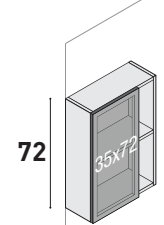

D	W	Code	13	2	3
21	50	PV72N3	-	519	545

**Door opens with hands. (No Handle - No Push-Pull)**

Price Groups

**Combinations:**  
**Matt White carcass - Polymeric front = price group 2**  
**Matt Colour carcass - Polymeric front = price group 3**

**13**  
**Polymeric**  
**only with**  
**lacquered carcass**

**2**  
**Matt**  
**White**

**3**  
**Matt**  
**Colour**

LH as drawer

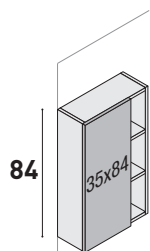

**Wall unit 1 door and open compartments, 2 wooden shelves.**  
 RH-LH version.



D	W	Code	13	2	3
21	• 50	PC82N3	-	514	541

LH as drawer

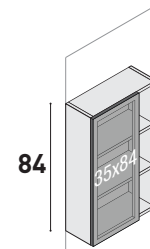

**Wall unit 1 door with black aluminium frame and open compartments, 2 wooden shelves.**  
 RH-LH version.



D	W	Code	13	2	3
21	50	PV82N3	-	591	621

LH as drawer

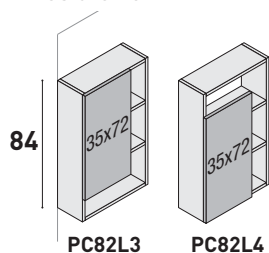

**Wall unit 1 door and open compartments**  
 RH-LH version.



D	W	Code	13	2	3
21	• 50	PC82L3	-	498	523
	• 50	PC82L4	-	498	523

LH as drawer

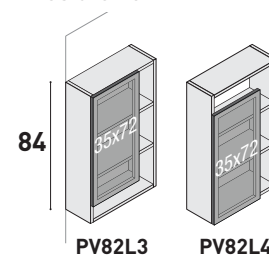

**Wall unit 1 door with black aluminium frame and open compartments, 1 glass shelf**  
 RH-LH version.



D	W	Code	13	2	3
21	50	PV82L3	-	577	607
	50	PV82L4	-	577	607

LH as drawer

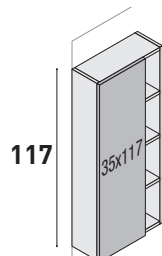

**Wall unit 1 door and open compartments, 3 wooden shelves.**  
 RH-LH version.



D	W	Code	13	2	3
21	50	PE341	-	671	706

LH as drawer

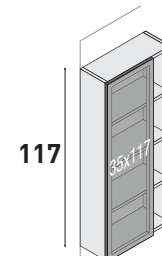

**Wall unit 1 door with black aluminium frame and open compartments, 3 wooden shelves.**  
 RH-LH version.



D	W	Code	13	2	3
21	50	PV341	-	753	791

	Price Groups		
	13	2	3
	Polymeric	Matt White	Matt Colour

### HORIZONTAL ONLY

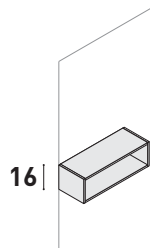

### Open wall unit with 1,2 cm Th. structure

Shelded hooks

\* Cannot be used under GROOVE System hung units 21cm depth

D	W	Code	13	2	3
<b>14</b>	35	<b>PE251</b>	-	235	247
	50	<b>PE252</b>	-	240	252
	60	<b>PE253</b>	-	247	260
	70	<b>PE254</b>	-	253	267
<b>21*</b>	35	<b>PE351</b>	-	235	247
	50	<b>PE352</b>	-	240	252
	60	<b>PE353</b>	-	247	260
	70	<b>PE354</b>	-	253	267

min 60 - max 150 cm  
HORIZONTAL ONLY

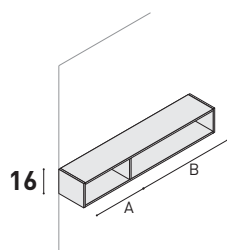

### Open tall unit per lm. with 1,2 cm Th. Structure. With 1 internal fixed division.

Shelded hooks

\* Cannot be used under GROOVE System hung units 21cm depth

D	W	Code	13	2	3
<b>14</b>	al lm.	<b>PE255</b>	-	468	492
<b>21</b>	al lm.	<b>PE355</b>	-	470	494

LH as drawer  
A = 1/3 width  
B = 2/3 width

### HORIZONTAL ONLY

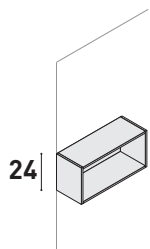

### Open wall unit with 1,2 cm Th. structure

Shelded hooks

\* Cannot be used under GROOVE System hung units 21cm depth

D	W	Code	13	2	3
<b>14</b>	35	<b>PE256</b>	-	240	252
	50	<b>PE257</b>	-	247	260
	60	<b>PE258</b>	-	253	267
	70	<b>PE259</b>	-	258	271
<b>21</b>	35	<b>PE356</b>	-	240	252
	50	<b>PE357</b>	-	247	260
	60	<b>PE358</b>	-	253	267
	70	<b>PE359</b>	-	258	271

min 60 - max 150 cm  
HORIZONTAL ONLY

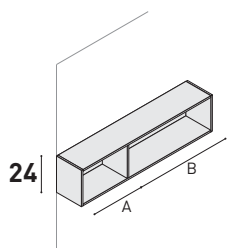

### Open tall unit per lm. with 1,2 cm Th. structure. With 1 internal fixed division.

Shelded hooks

\* Cannot be used under GROOVE System hung units 21cm depth

D	W	Code	13	2	3
<b>14</b>	al lm.	<b>PE260</b>	-	469	493
<b>21</b>	al lm.	<b>PE360</b>	-	479	503

LH as drawer  
A = 1/3 width  
B = 2/3 width

# Open wall units 12 mm Th.

	Price Groups		
	13	2	3
	Polymeric	Matt White	Matt Colour

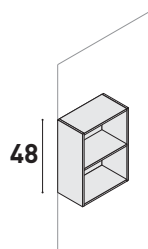

## Open wall unit with 1,2 cm Th. structure, with 1 shelf.

Shelded hooks

D	W	Code	13	2	3
<b>14</b>	25	PE261	-	278	292
	35	PE262	-	281	295
	50	PE263	-	296	312
<b>21</b>	25	PE361	-	278	292
	35	PE362	-	281	295
	50	PE363	-	296	312

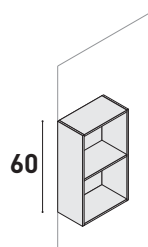

## Open wall unit with 1,2 cm Th. structure, with 1 shelf.

Shelded hooks

D	W	Code	13	2	3
<b>14</b>	25	PE264	-	280	294
	35	PE265	-	290	305
	50	PE266	-	308	324
<b>21</b>	25	PE364	-	280	294
	35	PE365	-	290	305
	50	PE366	-	308	324

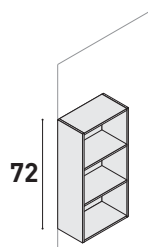

## Open wall unit with 1,2 cm Th. structure, with 2 shelves.

Shelded hooks

D	W	Code	13	2	3
<b>14</b>	25	PE267	-	328	345
	35	PE268	-	343	360
	50	PE269	-	365	383
<b>21</b>	25	PE367	-	335	352
	35	PE368	-	349	367
	50	PE369	-	372	391

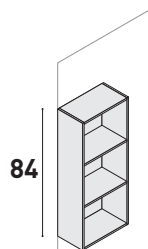

## Open wall unit with 1,2 cm Th. structure, with 2 shelves.

Shelded hooks

D	W	Code	13	2	3
<b>14</b>	25	PE270	-	338	356
	35	PE271	-	355	373
	50	PE272	-	380	400
<b>21</b>	25	PE370	-	356	374
	35	PE371	-	373	392
	50	PE372	-	399	420

## Open tall units 12 mm Th.

	Price Groups		
	13	2	3
	Polymeric	Matt White	Matt Colour

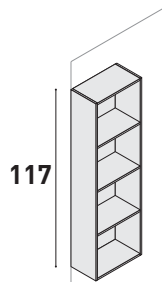

### Open tall unit with 1,2 cm Th. structure with 3 shelves.

Shelded hooks

D	W	Code	13	2	3
<b>14</b>	25	<b>PE273</b>	-	483	502
	35	<b>PE274</b>	-	508	527
<b>21</b>	25	<b>PE373</b>	-	486	504
	35	<b>PE374</b>	-	512	531

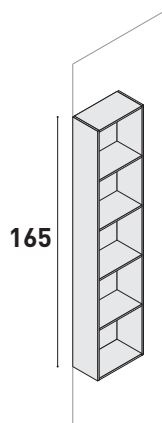

### Open tall unit with 1,2 cm Th. structure with 4 shelves.

Shelded hooks

D	W	Code	13	2	3
<b>14</b>	25	<b>PE275</b>	-	554	576
	35	<b>PE276</b>	-	589	611
<b>21</b>	25	<b>PE375</b>	-	621	645
	35	<b>PE376</b>	-	656	681

**Wall-hung element.**  
**On request supplied with plinth H.4 cm.**  
**Without surcharge.**

Price Groups

	13	2	3
	<b>Polymeric</b>	<b>Matt White</b>	<b>Matt Colour</b>

RH as drawer

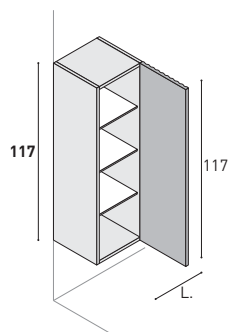

**Tall unit 1 door, 3 glass shelves.**

Optional top.  
 RH-LV version.

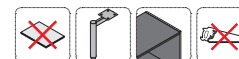

Page 5

D	W	Code	13	2	3
<b>21</b>	35	<b>CP225</b>	399	420	435
<b>35</b>	35	<b>CP325</b>	521	547	568

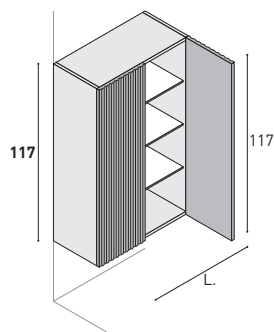

**Tall unit 2 doors, 3 glass shelves.**

Optional top.

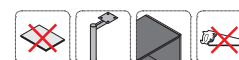

Page 5

D	W	Code	13	2	3
<b>21</b>	70	<b>CP235</b>	581	611	634
<b>35</b>	70	<b>CP335</b>	704	740	768

RH as drawer

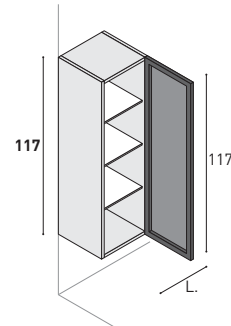

**Tall unit 1 door with black aluminium frame + Stop-sol glass, 3 glass shelves.**

Optional top.  
 RH-LV version.



Page 65

Page 5

D	W	Code	13	2	3
<b>21</b>	35	<b>CV271</b>	528	555	577
<b>35</b>	35	<b>CV272</b>	616	631	645

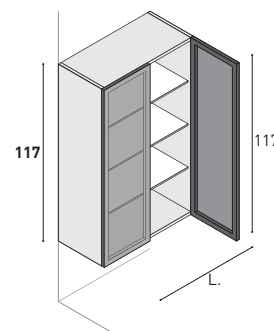

**Tall unit 2 doors with black aluminium frame + Stop-sol glass, 3 glass shelves.**

Optional top.

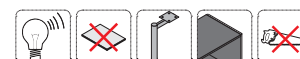

Page 65

Page 5

D	W	Code	13	2	3
<b>21</b>	70	<b>CV273</b>	839	876	887
<b>35</b>	70	<b>CV274</b>	922	937	974

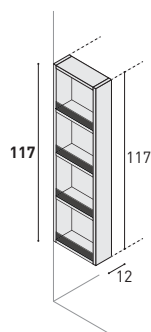

**End reversible void element H.117 cm with anti-fall glass.**

Element NOT for individual sale.



D	W	Code	13	2	3
<b>35</b>	12	<b>CL23L1</b>	-	400	420

	Price Groups		
	13	2	3
	Polymeric	Matt White	Matt Colour

RH as drawer

**Wall unit 2 doors, 4 glass shelves, 1 internal fixed division.**

RH-LH version.

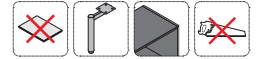

Page 5

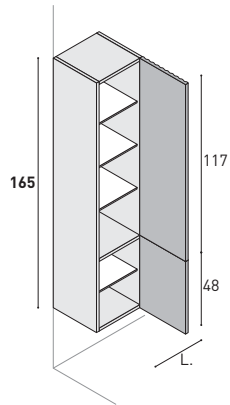

D	W	Code	13	2	3
21	35	CP601	543	570	592
35	35	CP621	578	608	631

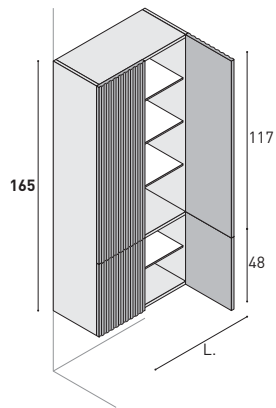

**Wall unit 4 doors, 4 glass shelves, 1 internal fixed division.**



Page 5

D	W	Code	13	2	3
21	70	CP617	820	862	895
35	70	CP637	868	912	948

RH as drawer

**Wall unit 1 upper door with black aluminium frame + Stop-sol glass, 1 lower door, 4 glass shelves, 1 internal fixed division.**

RH-LH version.

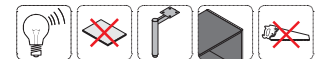

Page 65

Page 5

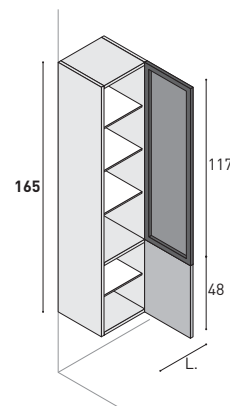

D	W	Code	13	2	3
21	35	CV630	640	652	678
35	35	CV631	668	682	710

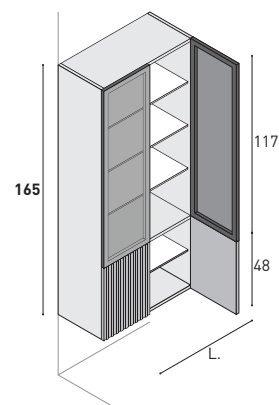

**Wall unit 2 upper doors with black aluminium frame + Stop-sol glass, 2 lower doors, 4 glass shelves, 1 internal fixed division.**

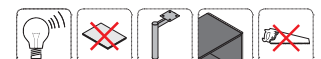

Page 65

Page 5

D	W	Code	13	2	3
21	70	CV632	1.000	1.032	1.074
35	70	CV633	1.056	1.081	1.124



	Price Groups		
	13	2	3
	Polymeric	Matt White	Matt Colour

RH as drawer

**Wall unit 2 doors with black aluminium frame + Stop-sol glass, 4 glass shelves, 1 internal fixed division.**  
RH-LH version.

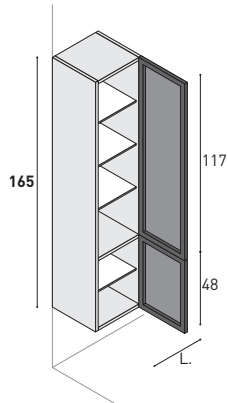
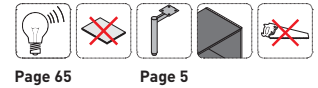

D	W	Code	13	2	3
21	35	CV601	762	775	806
35	35	CV621	795	806	838

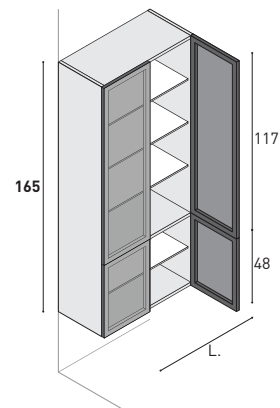

**Wall unit 4 doors with black aluminium frame + Stop-sol glass, 4 glass shelves, 1 internal fixed division.**

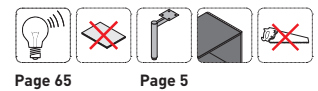

D	W	Code	13	2	3
21	70	CV617	1.232	1.256	1.306
35	70	CV637	1.274	1.303	1.355

RH as drawer

**Wall unit 1 door, 2 metal drawers, 3 glass shelves.**  
RH-LH version.

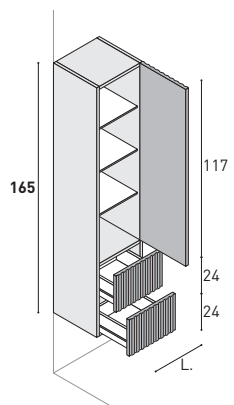

D	W	Code	13	2	3
35	35	CP682C	762	800	831

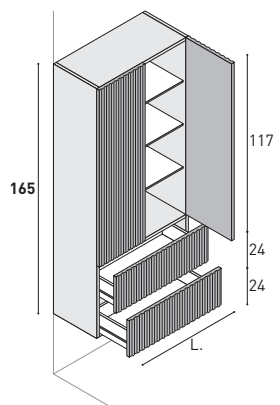

**Wall unit 2 doors, 2 metal drawers, 3 glass shelves.**



D	W	Code	13	2	3
35	• 70	CL43D5	1.026	1.077	1.118

	Price Groups		
	13	2	3
	Polymeric	Matt White	Matt Colour

RH as drawer

**Wall unit 1 door with black aluminium frame + Stop-sol glass, 2 metal drawers, 3 glass shelves.**  
RH-LH version.

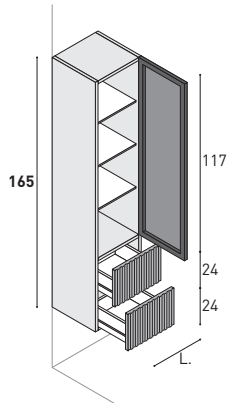

D	W	Code	13	2	3
35	35	CV634	880	924	960

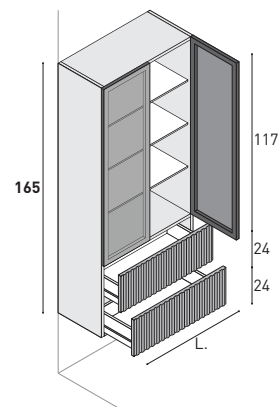

**Wall unit 2 doors with black aluminium frame + Stop-sol glass, 2 metal drawers, 3 glass shelves.**



D	W	Code	13	2	3
35	• 70	CV635	1.263	1.327	1.378

RH as drawer

**Wall unit 1 door, 2 drawers with black aluminium frame + Stop-sol glass, 3 glass shelves.**  
RH-LH version.

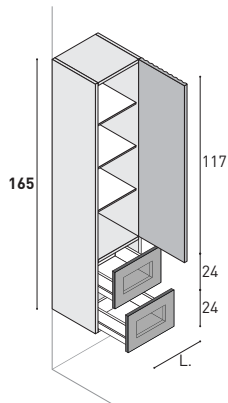
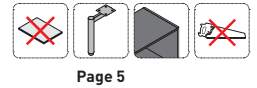

D	W	Code	13	2	3
35	35	CV634C	1.017	1.069	1.109

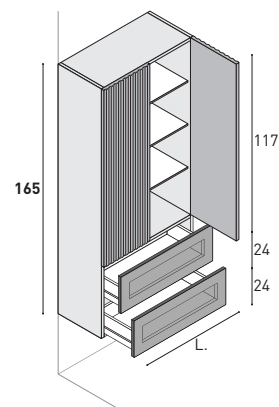

**Wall unit 2 doors, 2 drawers with black aluminium frame + Stop-sol glass, 3 glass shelves.**

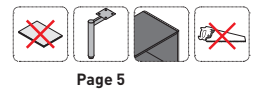

D	W	Code	13	2	3
35	• 70	CV635C	1.295	1.360	1.412

# Wall-hung tall units

stonewood®

H. 165 cm

	Price Groups		
	13	2	3
	Polymeric	Matt White	Matt Colour

RH as drawer

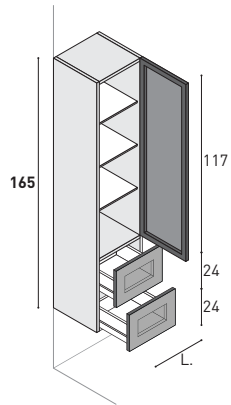

**Wall unit 1 door with black aluminium frame + Stop-sol glass, 2 metal drawers with black aluminium frame + Stop-sol glass, 3 glass shelves.**

RH-LH version.

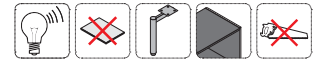

D	W	Code	13	2	3
35	35	CV640	1.118	1.174	1.219

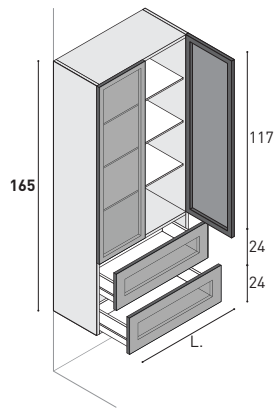

**Wall unit 2 doors with black aluminium frame + Stop-sol glass, 2 metal drawers with black aluminium frame + Stop-sol glass, 3 glass shelves.**

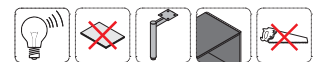

D	W	Code	13	2	3
35	• 70	CV641	1.520	1.597	1.657



2 LED lights kit, with sensor (12V - K°4000 - 9,6W/ml)

**MG105** 198 each part

	Price Groups		
	13	2	3
	Polymeric	Matt White	Matt Colour

RH as drawer

Open tall unit, for changing depths, 5 wooden shelves

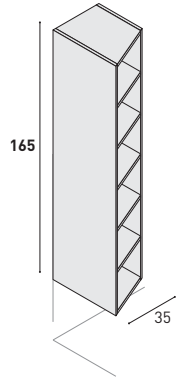

D	W	Code	13	2	3
35/21	35	CG601	-	569	604
51/35	35	CG602	-	623	657

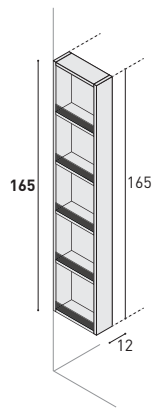

End reversible void element with anti-fall glass.  
For H.165 cm. tall units  
Element NOT for individual sale.



D	W	Code	13	2	3
35	12	CL43L1	-	479	503

TALL UNITS HEIGHT with VERTIGO FEET

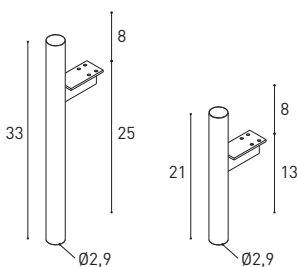
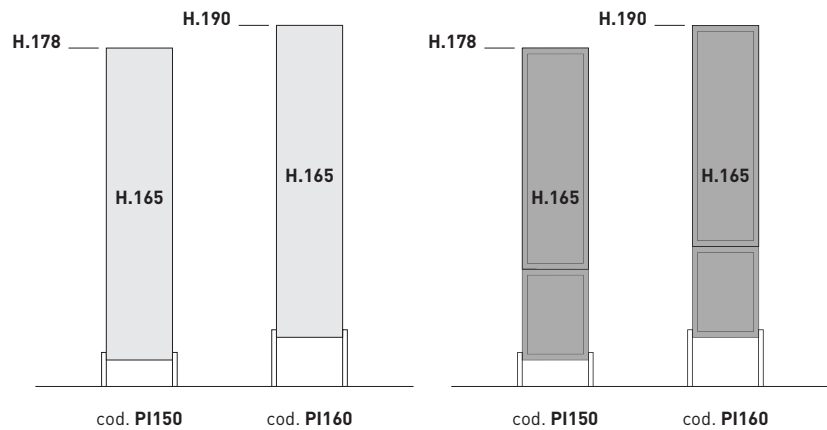

Vertigo foot.  
NON-bearing element, always fix units and columns to the wall.

H	Code	Matt Black Price	Art Brass Brushed Bronze Oxide Price
21	PI150	66 each	105 each
33	PI160	72 each	110 each

**Wall-hung element.**  
**On request supplied with plinth H.4 cm.**  
**Without surcharge.**

Price Groups

13	2	3
Polymeric	Matt White	Matt Colour

RH as drawer

**Wall unit 2 doors, 4 Stop-sol glass shelves, 1 internal fixed division.**  
 RH-LH version.

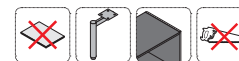

Page 5

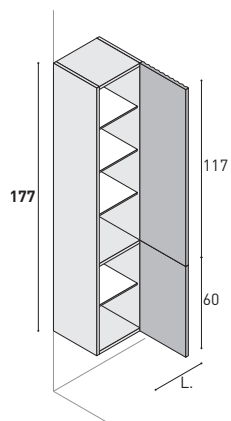

D	W	Code	13	2	3
21	35	CP701	583	613	636
35	35	CP721	625	657	682

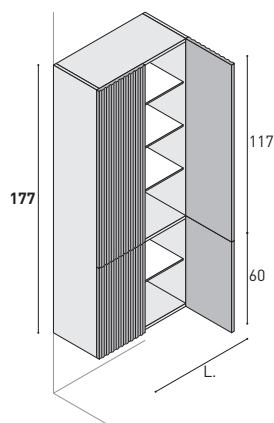

**Wall unit 4 doors, 4 Stop-sol glass shelves, 1 internal fixed division.**

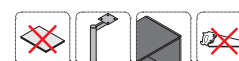

Page 5

D	W	Code	13	2	3
21	70	CP717	854	897	931
35	70	CP737	910	956	993

RH as drawer

**Wall unit 2 doors with black aluminium frame + Stop-sol glass,**  
**4 Stop-sol glass shelves, 1 internal fixed division.**  
 RH-LH version.

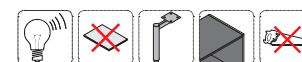

Page 69

Page 5

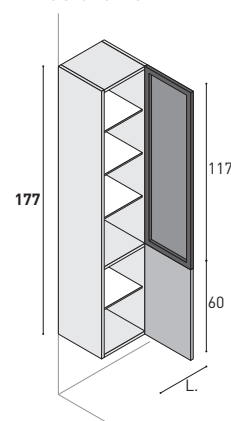

D	W	Code	13	2	3
21	35	CV701	740	777	807
35	35	CV721	774	813	844

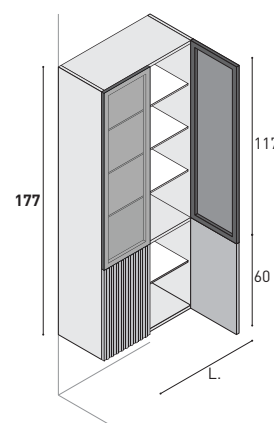

**Wall unit 4 doors with black aluminium frame + Stop-sol glass,**  
**4 Stop-sol glass shelves, 1 internal fixed division.**

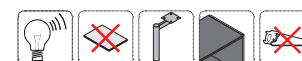

Page 69

Page 5

D	W	Code	13	2	3
21	70	CV717	1.155	1.214	1.260
35	70	CV737	1.217	1.279	1.327

**Wall-hung element.**  
**On request supplied with plinth H.4 cm.**  
**Without surcharge.**

Price Groups

13	2	3
Polymeric	Matt White	Matt Colour

RH as drawer

**Wall unit 1 door, 1 metal drawer with black aluminium frame + Stop-sol glass, 1 door, 3 glass shelves.**  
 RH-LH version.

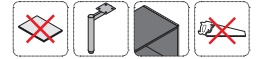

Page 5

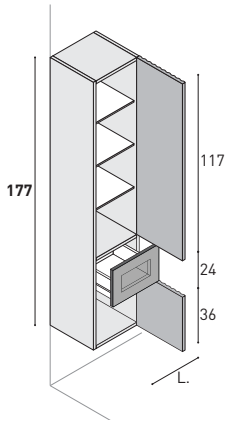

D	W	Code	13	2	3
35	35	CV783C	879	923	959

**Wall unit 2 doors, 1 metal drawer with black aluminium frame + Stop-sol glass, 2 doors, 3 glass shelves.**

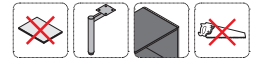

Page 5

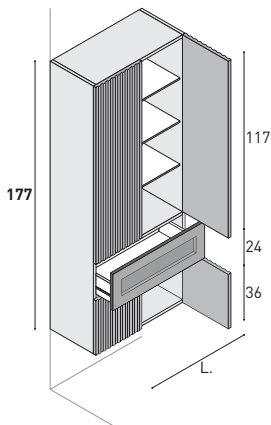

D	W	Code	13	2	3
35	70	CV784C	1.202	1.262	1.311

RH as drawer

**Wall unit 1 door with black aluminium frame + Stop-sol glass, 1 metal drawer with black aluminium frame + Stop-sol glass, 1 door, 3 glass shelves.**  
 RH-LH version.



Page 5

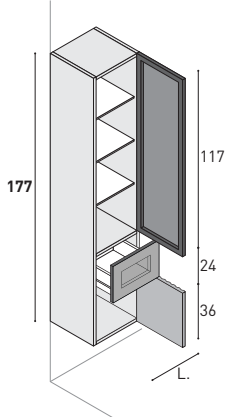

D	W	Code	13	2	3
35	35	CV782C	993	1.043	1.083

**Wall unit 2 doors with black aluminium frame + Stop-sol glass, 1 metal drawer with black aluminium frame + Stop-sol glass, 2 doors, 3 glass shelves.**



Page 5

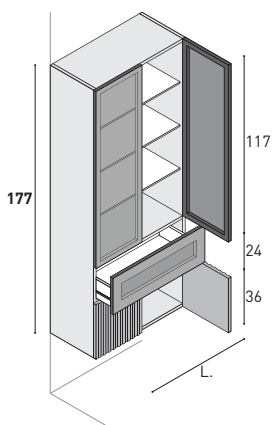

D	W	Code	13	2	3
35	70	CV6305	1.429	1.501	1.558

**Wall-hung element.**  
**On request supplied with plinth H.4 cm.**  
**Without surcharge.**

Price Groups

13	2	3
Polymeric	Matt White	Matt Colour

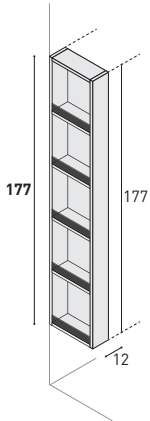

**End reversible void element with anti-fall glass.**  
**For H.177 cm. tall units**  
 Element NOT for individual sale.



D	W	Code	13	2	3
<b>35</b>	12	<b>CL63L1</b>	-	510	535



2 LED lights kit, with sensor (12V - K°4000 - 9,6W/ml)

**MG105** 198 each part

**Element with H.4 cm plinth  
On request supplied suspended.  
Without surcharge.**

Price Groups

13	2	3
Polymeric	Matt White	Matt Colour

RH as drawer

**Wall unit 2 doors, 5 glass shelves, 1 internal fixed division.**  
RH-LH version.

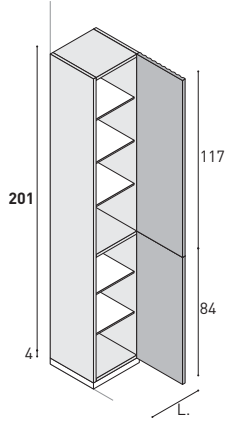

D	W	Code	13	2	3
<b>21</b>	35	<b>CL82N2</b>	588	618	642
<b>35</b>	35	<b>CL83N2</b>	709	745	773

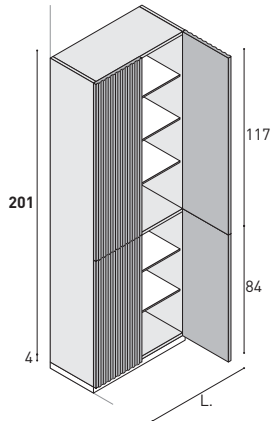

**Wall unit 4 doors, 5 glass shelves, 1 internal fixed division.**



D	W	Code	13	2	3
<b>21</b>	70	<b>CL82M5</b>	915	961	997
<b>35</b>	70	<b>CL83M5</b>	1.052	1.105	1.148

RH as drawer

**Wall unit 1 upper door with black aluminium frame + Stop-sol glass, 1 lower door, 5 glass shelves, 1 internal fixed division.**  
RH-LH version.



Page 69

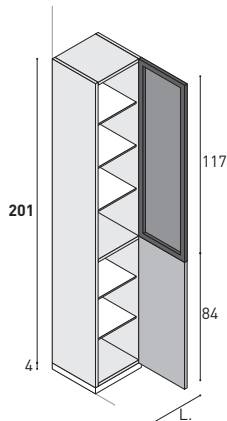

D	W	Code	13	2	3
<b>21</b>	35	<b>CL82V2</b>	764	776	797
<b>35</b>	35	<b>CL83V2</b>	830	843	866

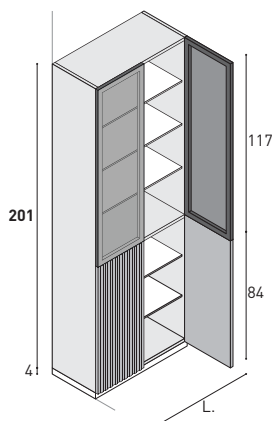

**Wall unit 2 upper doors with black aluminium frame + Stop-sol glass, 2 lower doors, 5 glass shelves, 1 internal fixed division.**



Page 69

D	W	Code	13	2	3
<b>21</b>	70	<b>CL82V5</b>	1.190	1.199	1.220
<b>35</b>	70	<b>CL83V5</b>	1.285	1.298	1.330



**Element with H.4 cm plinth**  
**On request supplied suspended.**  
**Without surcharge.**

Price Groups

	13	2	3
	<b>Polymeric</b>	<b>Matt White</b>	<b>Matt Colour</b>

RH as drawer

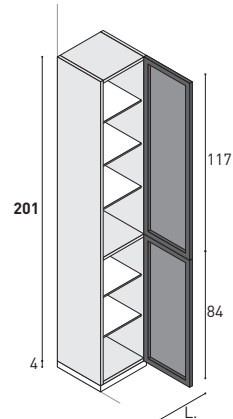

**Wall unit 2 doors with black aluminium frame + Stop-sol glass, 5 glass shelves, 1 internal fixed division.**

RH-LH version.



Page 69

D	W	Code	13	2	3
<b>21</b>	35	<b>CV82N2</b>	843	855	861
<b>35</b>	35	<b>CV83N2</b>	961	974	999

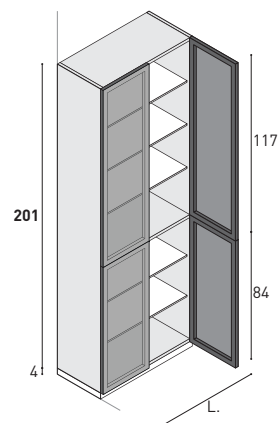

**Wall unit 4 doors with black aluminium frame + Stop-sol glass, 5 glass shelves, 1 internal fixed division.**



Page 69

D	W	Code	13	2	3
<b>21</b>	70	<b>CV82M5</b>	1.393	1.406	1.419
<b>35</b>	70	<b>CV83M5</b>	1.524	1.536	1.549

RH as drawer

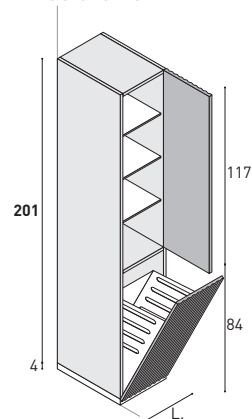

**Wall unit 1 door, 3 glass shelves, 1 internal fixed division, 1 laundry basket in anthracite finish metal sheet.**

**Push-pull opening excluded**

RH-LH version.



D	W	Code	13	2	3
<b>51</b>	35	<b>CL85B2</b>	1.032	1.084	1.126
<b>67</b>	35	<b>CL87B2</b>	1.169	1.228	1.274

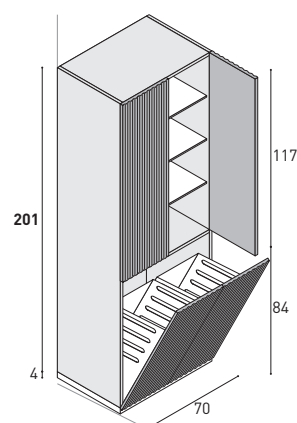

**Wall unit 2 doors, 3 glass shelves, 1 internal fixed division, 2 laundry baskets in anthracite finish metal sheet.**

**Push-pull opening excluded**



D	W	Code	13	2	3
<b>51</b>	70	<b>CL85B5</b>	1.374	1.444	1.499
<b>67</b>	70	<b>CL87B5</b>	1.536	1.613	1.675

	Price Groups		
	13	2	3
	Polymeric	Matt White	Matt Colour

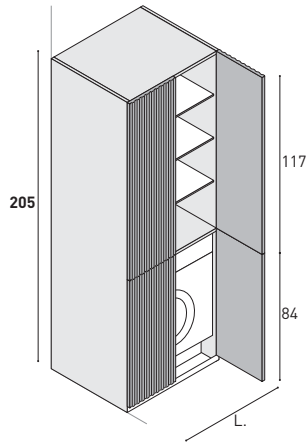

### Tall unit for washing machine, 4 doors, 3 glass shelves, removable plinth.

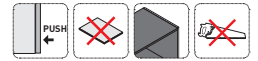

Check exact sizes of the washing machine, including portholes and drains, before purchasing.

**Important: in case of washer-dryer, the appliance must always work with open doors.**

D	W	Code	13	2	3
51	• 70	<b>CT85M5A</b>	1.217	1.279	1.327
Useful interior dimensions: W.61 - D.45,5 - H.87					
60	• 70	<b>CT86M6A</b>	1.304	1.370	1.422
Useful interior dimensions: W.61 - D.54,5 - H.87					
67	• 70	<b>CT87M7A</b>	1.375	1.445	1.500
Useful interior dimensions: W.61 - D.61,5 - H.87					

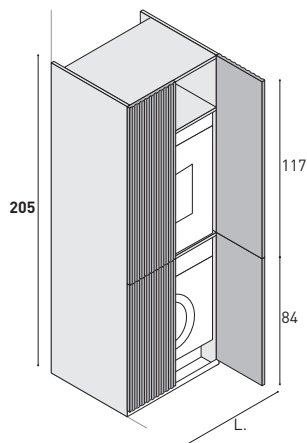

### Tall unit for washing machine and dryer machine, 4 doors, 3 glass shelves, removable plinth.



Check exact sizes of the washing machine, including portholes and drains, before purchasing.

**Important: in case of washer-dryer, the appliance must always work with open doors.**

D	W	Code	13	2	3
51	• 70	<b>CT85M5B</b>	1.165	1.224	1.271
Useful interior dimensions: W.61 - D.45,5 - H.87 (113)					
60	• 70	<b>CT86M6B</b>	1.252	1.315	1.366
Useful interior dimensions: W.61 - D.54,5 - H.87 (113)					
67	• 70	<b>CT87M7B</b>	1.316	1.382	1.435
Useful interior dimensions: W.61 - D.61,5 - H.87 (113)					

	Finishes	
	<b>Matt Black</b>	<b>Art Brass Brushed Bronze Oxide</b>

**Metal towel holder BLADE.**

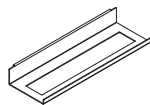

D.	W	H	Code	Price	Price
<b>13,4</b>	40	5,3	<b>AS600</b>	58	95

**Metal wall paper-roll holder BLADE.**



D.	W	H	Code	Price	Price
<b>13,4</b>	15	5,3	<b>AS601</b>	38	55

RH as drawer

**Shaped shelf BLADE, to match with wall mirrors, 2,5 cm Th.**

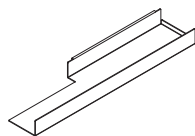

LH as drawer

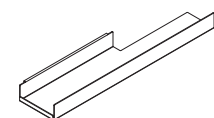

D.	W	H	Code	Price	Price
<b>13,4</b>	60	5,3	<b>AS602</b>	72	118

**Wall shelf BLADE.**

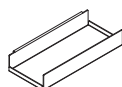

D.	W	H	Code	Price	Price
<b>13,4</b>	30	5,3	<b>AS603</b>	53	87
	60	5,3	<b>AS604</b>	70	108

**Under mirror shelf.**

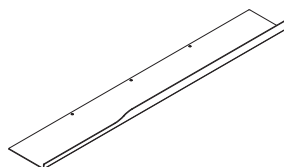

D.	W	H	Code	Price	Price
<b>13,4</b>	90	3	<b>AS605</b>	71	121

# SUN and BLACK mirrors without lighting

	Finishes	
	<b>Matt White</b>	<b>S11 ART Brass</b>

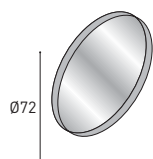

**SUN mirror, with metal frame. Without lighting.**  
**Without socket and switch.**



	Th.	Ø	Code	Price	Price
BRASS finish: delivery +15 gg	<b>4,5</b>	72	<b>SP462</b>	238	508

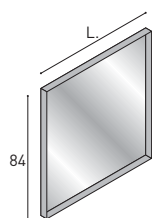

**BLACK mirror, with matt Black aluminium frame. Without lighting.**  
**Without socket and switch.**  
**Available in fixed size.**  
 Suitable lamp: FA343 DUAL only



	Th.	W	H	Code	Price
<b>4,5</b>		60	84	<b>SP811</b>	220
		80	84	<b>SP812</b>	251

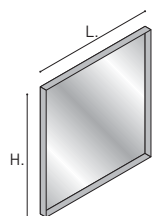

**BLACK mirror, with matt Black aluminium frame. Without lighting.**  
**Without socket and switch.**  
**Available per s.m.**  
 Suitable lamp: FA343 DUAL only

Example mirror W.1,45 H.70  
 $(1,45 \times 70) = 1,015 \text{ m}^2$   
 $1,015 \times \text{€ } 506 = \text{€ } 514$

**Min. and max sizes:**  
**min. 60 x 60 cm**  
**max 200 x 120 cm**

	Th.	s.m.	Code	Price
<b>4,5</b>		< 0,70 m <sup>2</sup>	<b>SP810</b>	396
		0,71 ÷ 0,90 m <sup>2</sup>	....	458
		> 0,91 m <sup>2</sup>	....	506

# SUN and BLACK mirrors with lighting

	Finishes	
	<b>Matt White</b>	<b>S11 ART Brass</b>

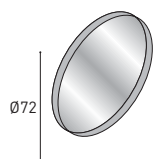

**SUN mirror, with metal frame and LED lighting.**  
Without socket and switch.



4000 °K  
10,8 Watt  
IP 44

BRASS finish: delivery +15 gg

Th.	∅	Code	Price	Price
<b>4,5</b>	72	<b>SP461</b>	396	663

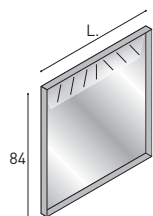

**BLACK mirror, with matt Black aluminium frame and LED lighting on upper edge.**  
Without socket and switch.  
Available in fixed size.



4000 °K  
9,6 Watt per sq.m.  
IP 20

Th.	W	H	Code	Price
<b>4,5</b>	60	84	<b>SP801</b>	319
	80	84	<b>SP802</b>	359

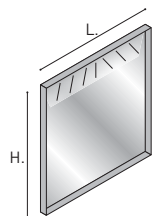

**BLACK mirror, with matt Black aluminium frame and LED lighting on upper edge.**  
Without socket and switch.  
Available per s.m.

4000 °K  
9,6 Watt per sq.m.  
IP 20

Example mirror W.1,45 H.70  
(1,45 x 70) = 1,015 m<sup>2</sup>  
1,015 x € 655 = € 665

**Min. and max sizes:**  
**min. 60 x 60 cm**  
**max 200 x 120 cm**

Th.	s.m.	Code	Price
<b>4,5</b>	< 0,70 m <sup>2</sup>	<b>SP800</b>	523
	0,71 ÷ 0,90 m <sup>2</sup>	....	601
	> 0,91 m <sup>2</sup>	....	655



For mirrors



For container mirrors

**PRICE**



**STICK lamp per linear meter in Black finish.**

Only for SP900 mirror.  
Max lenght 200 cm.



LED 10 Watt/ml  
230V with transformer  
6000 °K  
IP 44

H	D	W	Code	Price
1	1	sq.m.	<b>FA348</b>	157 (minimum billable)



**VERTIGO lamp.**

Installation can be made both Horizontally and Vertically.  
Protruding part 15 cm.



LED 5 Watt/ml  
230V with transformer  
4000 °K  
IP 44

Th.	D	W	Code	Price
1,5	6	50	<b>FA347</b>	146

**Completion top for side-by-side bases in Betacryl White**  
**Matt depth 51,3 cm**  
**Item TB104 € 471,00 / lm**  
**Other tops , please check GENERAL PRICELIST**

Price
Supplied <b>WITHOUT</b> drain system

**WRAP 1 console with towel compartment and lateral tap**

Matt White Betacryl and Ocritech

1 lateral tap hole  
 basin with lateral chute  
 RH or LH version.

LH as drawer

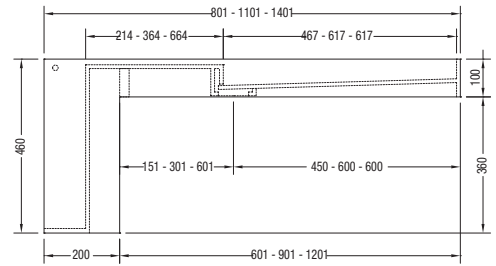
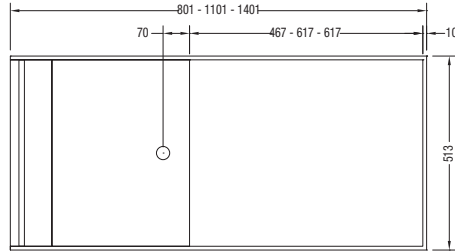
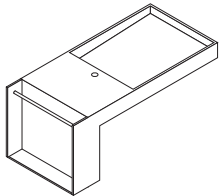

W	Basin	Code	Betacryl	Code	Ocritech
80	46,7	<b>COL140</b>	1.814	<b>COL142</b>	1.593
110	61,7	<b>COL145</b>	1.965	<b>COL147</b>	1.914
140	61,7	<b>COL150</b>	2.191	<b>COL152</b>	2.354

Towel rail ONLY Matt black

**WRAP 2 console with towel compartment and central tap**

Matt White Betacryl and Ocritech

1 central tap hole  
 basin with rear chute  
 RH or LH version.

LH as drawer

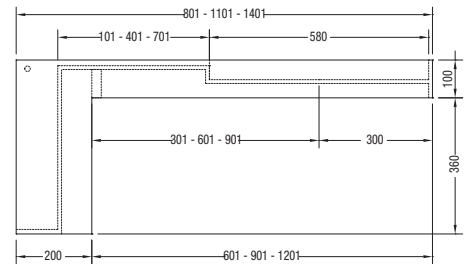
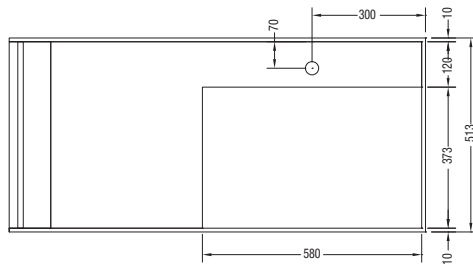
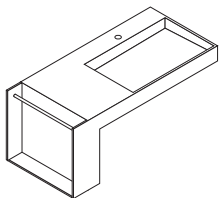

W	Basin	Code	Betacryl	Code	Ocritech
80	58	<b>COL160</b>	2.002	<b>COL162</b>	1.593
110	58	<b>COL165</b>	2.167	<b>COL167</b>	1.914
140	58	<b>COL170</b>	2.420	<b>COL172</b>	2.354

Towel rail ONLY Matt black

**WRAP 1 console with lateral tap hole**

**WRAP 2 console with central tap hole**

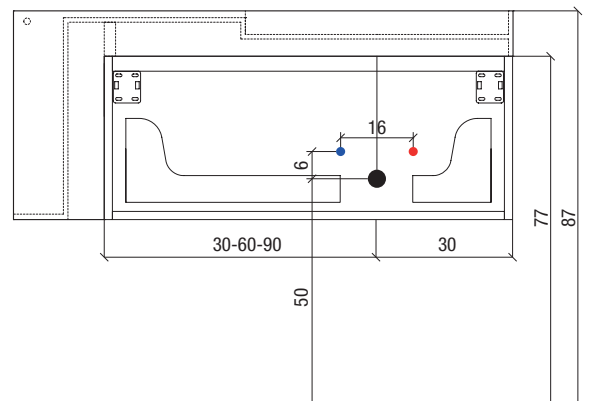
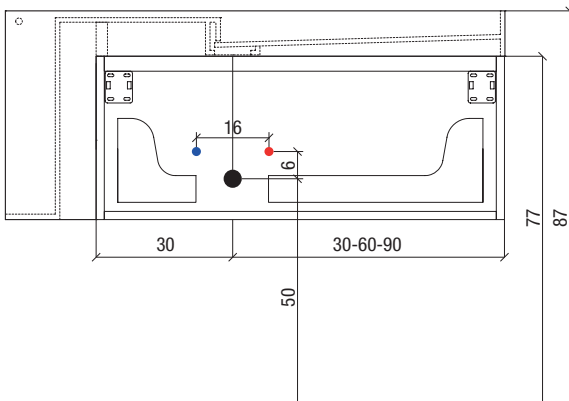

Price Groups		
Polymeric	Matt White	Matt Colour
Bronze Metallik Rovere Grain Dark Rockford Burbon Oak Thermo A Fruit Wood	Matt White	<b>48</b> Matt Colours (see Samples)

**NOTE:**

For all kinds of tops, please see **GENERAL PRICELIST (pages 398-443)**.

**POLYMERIC**

Made in MDF coated Polymeric, anthracite bottom side finish.

**LACQUERED**

Made of wood particle board panels, edged with polyurethane glue in order to increase its resistance in a humid environment. Finished with a primer coat of preparation and three coats of paint in color.

**Maintenance:**

We recommend drying after each use, to avoid stagnation of water or soap that could affect the resistance of the surface. The cleaning must be carried out with a damp cloth and a solution of 20% neutral soap and water, then wipe again with a cloth moist, well rinsed and without soap. DO NOT use solvents, alcohol or abrasive products.

**NOTES FOR SIZES:**

- All tops, of any material, are made by increasing of:  
**WOODEN tops → +4 mm (2 mm for each side) the nominal furniture size.**  
**BOXED tops → +0 mm (the nominal top size)**  
**Other tops → +10 mm (5 mm for each side) the nominal furniture size.**
- Depth measure can vary, compared to that indicated, according to the furniture model chosen.

**IMPORTANT NOTES:**

- ALWAYS ADVISE IF FURNITURE GOES IN A NICHE OR PLACED WITH A SIDE CLOSED TO THE WALL.
- In case of washbasin not supplied by PUNTOTRE, send a technical sheet of the basin with mixer hole position.
- In the presence of a WALL MIXER, always send a technical sheet of the tap chosen.

**Support brackets**

**Standard plugs supplied.**

Special plugs for drywall or other needs shall be found locally.

**Brackets for tops.**

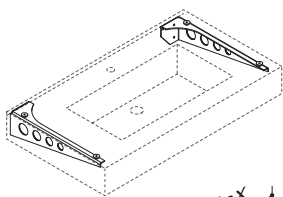

2 Brackets

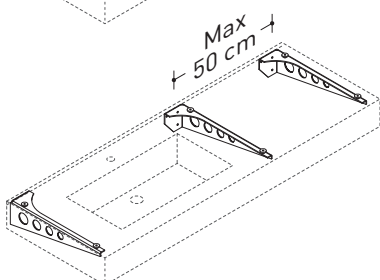

2 Brackets  
+ 1 Side bracket each 50 cm

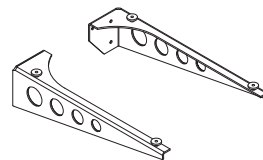

**NOTE: Can be used only with boxed tops of 95 mm min. height.**

	Code	Price
<b>For Top D.35,5</b>	1 RH bracket	<b>SS811</b> 42
	1 LH bracket	<b>SS812</b> 42
	2 brackets	<b>SS813</b> 83
	3 brackets	<b>SS814</b> 124
<b>For Top D.46 D.51,5</b>	1 RH bracket	<b>SS801</b> 47
	1 LH bracket	<b>SS802</b> 47
	2 brackets	<b>SS803</b> 92
	3 brackets	<b>SS804</b> 137



Overall plate **WITHOUT HOLE** Th.1,8 cm per linear meter.  
Max length 270 cm.

**Minimum billable 0,5 mt**

STRAIGHT edge

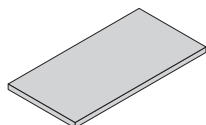

**Not suitable for mounting on brackets.**  
**POLYMERIC max.250 cm length**

D	Code	Polymeric	Matt White	Matt Colour
35,5	<b>TL107</b>	126	181	190
46	<b>TL118</b>	136	214	214
51,5	<b>TL109</b>	146	225	238

**Surcharge overstanding additional holes.**

Price including any mixer hole.

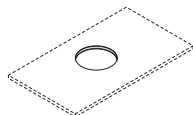

**NOT available on top th. 12mm**

	Code	Price
each	<b>MG150</b>	71

**Top for semi-fitted and overstanding basins.**

Including:

1 basin hole

1 mixer hole

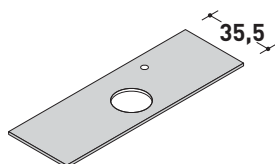

STRAIGHT edge



W	Code straight edge	Polymeric	Matt White	Matt Colour
70	<b>TL120</b>	118	157	163
80	<b>TL121</b>	131	175	182
90	<b>TL122</b>	143	193	201
100	<b>TL123</b>	156	211	219
110	<b>TL124</b>	169	229	239
120	<b>TL125</b>	181	247	258
130	<b>TL126</b>	194	266	277
140	<b>TL127</b>	206	283	295
150	<b>TL128</b>	218	301	314
160	<b>TL129</b>	231	319	334
170	<b>TL130</b>	244	337	352
180	<b>TL131</b>	257	356	371
190	<b>TL132</b>	269	373	390
200	<b>TL133</b>	281	391	409
210	<b>TL134</b>	294	410	428
220	<b>TL135</b>	306	427	447
230	<b>TL136</b>	319	446	466
240	<b>TL137</b>	332	464	484
250	<b>TL138</b>	346	483	505
260	<b>TL139</b>	-	503	525
270	<b>TL140</b>	-	522	545

Note: For middle measures always consider the wider article.

**Top for overstanding basins.**

Including:  
1 basin hole  
1 mixer hole

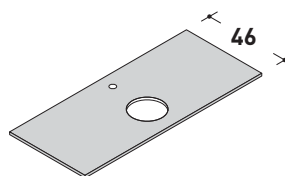

STRAIGHT edge



**POLYMERIC max.250 cm lenght**

Additional holes see page 79

W	Code	Polymeric	Matt White	Matt Colour
70	<b>TL710</b>	126	180	211
80	<b>TL711</b>	139	202	237
90	<b>TL712</b>	152	223	261
100	<b>TL713</b>	165	244	285
110	<b>TL714</b>	180	266	311
120	<b>TL715</b>	193	286	336
130	<b>TL716</b>	206	308	361
140	<b>TL717</b>	220	329	385
150	<b>TL718</b>	234	350	411
160	<b>TL719</b>	247	372	436
170	<b>TL720</b>	261	393	460
180	<b>TL721</b>	274	415	487
190	<b>TL722</b>	288	436	511
200	<b>TL723</b>	301	457	535
210	<b>TL724</b>	315	479	560
220	<b>TL725</b>	328	500	586
230	<b>TL726</b>	341	522	611
240	<b>TL727</b>	356	543	635
250	<b>TL728</b>	370	566	663
260	<b>TL729</b>	-	588	688
270	<b>TL730</b>	-	611	715

Note: For middle measures always consider the wider article.

**Top for overstanding basins.**

Including:  
1 basin hole  
1 mixer hole

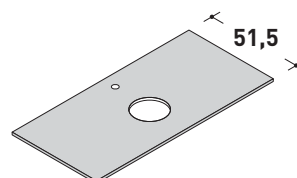

STRAIGHT edge



**POLYMERIC max.250 cm lenght**

Additional holes see page 79

W	Code bordo dritto	Polymeric	Matt White	Matt Colour
70	<b>TL150</b>	132	187	197
80	<b>TL151</b>	147	211	220
90	<b>TL152</b>	161	233	245
100	<b>TL153</b>	175	255	268
110	<b>TL154</b>	191	278	292
120	<b>TL155</b>	205	300	316
130	<b>TL156</b>	219	323	339
140	<b>TL157</b>	234	345	363
150	<b>TL158</b>	248	367	387
160	<b>TL159</b>	263	390	411
170	<b>TL160</b>	278	412	435
180	<b>TL161</b>	292	435	458
190	<b>TL162</b>	306	457	482
200	<b>TL163</b>	321	479	505
210	<b>TL164</b>	336	502	530
220	<b>TL165</b>	350	524	554
230	<b>TL166</b>	365	547	577
240	<b>TL167</b>	379	569	601
250	<b>TL168</b>	395	593	626
260	<b>TL169</b>	-	618	652
270	<b>TL170</b>	-	641	677

Note: For middle measures always consider the wider article.

**Boxed top for overstanding basins.**

Including:  
1 basin hole  
1 mixer hole

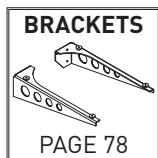

**ALWAYS** required support brackets for boxed tops

★ Thickness may vary between 6-12cm with no surcharge. For standard brackets, minimum height is 9,5cm.

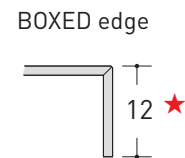
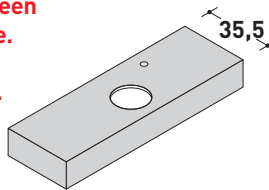

Additional holes see page 79

W	Code	Polymeric	Matt White	Matt Colour
70	TL180	351	418	448
80	TL181	361	428	461
90	TL182	368	439	472
100	TL183	389	456	491
110	TL184	406	477	515
120	TL185	423	500	538
130	TL186	457	527	578
140	TL187	483	569	619
150	TL188	503	589	637
160	TL189	517	615	662
170	TL190	537	636	679
180	TL191	558	659	704
190	TL192	581	682	737
200	TL193	602	708	765
210	TL194	627	735	791
220	TL195	656	766	821
230	TL196	-	789	851
240	TL197	-	808	866
250	TL198	-	842	902
260	TL199	-	876	939
270	TL200	-	909	975

Note: For middle measures always consider the wider article.

**Boxed top for overstanding basins.**

Including:  
1 basin hole  
1 mixer hole

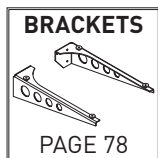

**ALWAYS** required support brackets for boxed tops

★ Thickness may vary between 6-12cm with no surcharge. For standard brackets, minimum height is 9,5cm.

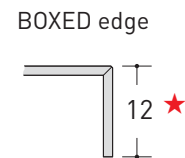
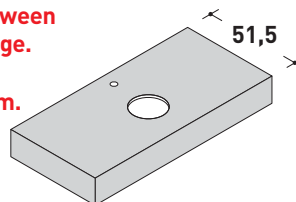

Additional holes see page 79

W	Code	Polymeric	Matt White	Matt Colour
70	TL210	377	448	481
80	TL211	388	460	495
90	TL212	395	472	508
100	TL213	417	489	527
110	TL214	436	512	554
120	TL215	454	537	578
130	TL216	490	566	621
140	TL217	520	611	665
150	TL218	541	632	686
160	TL219	556	660	710
170	TL220	577	685	731
180	TL221	599	708	757
190	TL222	624	733	791
200	TL223	647	761	821
210	TL224	674	789	851
220	TL225	704	822	883
230	TL226	-	849	915
240	TL227	-	867	931
250	TL228	-	904	971
260	TL229	-	940	1.009
270	TL230	-	976	1.048

Note: For middle measures always consider the wider article.

Price Groups

Ocritech® White (matt and glossy finish)



OC01 Matt White



OC02 Glossy White

Ocritech® Colour (matt finish)



OC03 Grigio scuro



OC04 Cappuccino



OC05 Grigio chiaro

**ORDINABLE ONLY  
in the combinations:**

Top White / Bowl Colour  
Top Colour / Bowl White

Ocritech® coated HPL (matt finish)

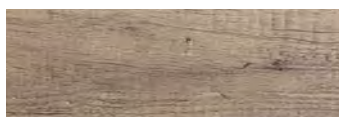

H014 Rovere 0669

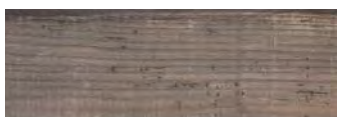

H015 Old Wood 0677



H068 Zement 1460



H033 Rock Climb 596

**OCRITECH®** is a mixture of high quality inert powders, aluminum tri-hydrate and acrylic resin. The result is a white matt finish, compact in the entire thickness (SOLID-SURFACE), with a very low absorbency, that can be restored. OCRITECH® is a very compact and uniform material. Recovery can include serious harm, such as deep scratches, which can be removed by fine glass-paper or abrasive sponge Scotch-Brite®. OCRITECH® contains no pollutants and is resistant to UV rays.

**Maintenance:**

Be careful, solvents, can damage the material. For daily cleaning use a damp microfiber cloth. Each delivery includes a set of recovery with Scotch-Brite®. It is recommended once a year to treat the surface with the Scotch-Brite® sponge to restore the original finish and remove the natural oxidation of the product.

**Integrated bowl.**

Matt White or Glossy White bowl.  
Supplied **WITHOUT** drain system.  
Basin **WITHOUT** overflow hole. (Available on request).

**i** Basin NOT suitable for D.46 cm base units

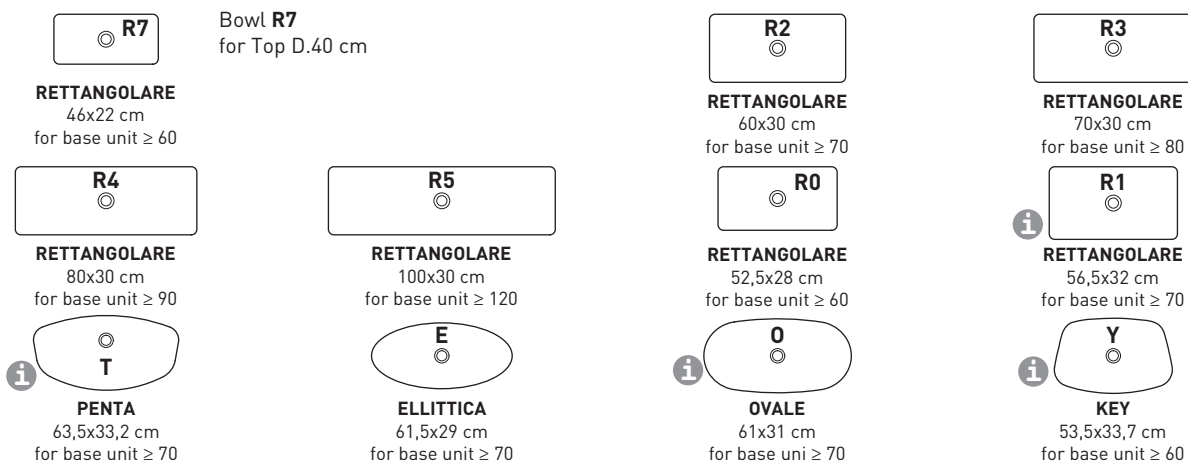

Overail plate WITHOUT HOLE Th.1,2 cm per linear meter.

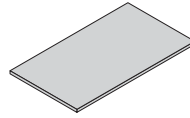
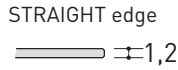

D	Code	White	Colour	Coated HPL
35,5	<b>T0102</b>	268	348	158
45	<b>T0105</b>	377	490	219
51,5	<b>T0104</b>	377	490	219

Upstanding, price per linear meter.

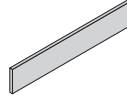
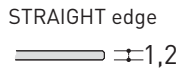

H	Code	White	Colour	Coated HPL
4-9	<b>AT011</b>	69	103	97
10-24	<b>AT012</b>	194	239	178
25-35	<b>AT013</b>	268	348	259

Surcharge overstanding additional holes.

Price including any mixer hole.

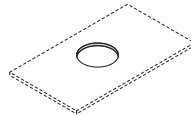

Code	Price
each <b>MG156</b>	47

Surcharge for additional moulded bowls.

Price including any mixer hole.

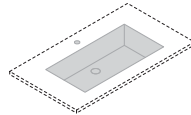

Code	Price
each <b>MG306</b>	167

Surcharge for tap with 3 holes.

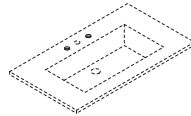

Code	Price
each <b>MG266</b>	41

Surcharge for overflow hole.

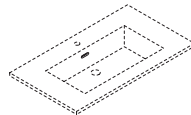

Code	Price
each <b>MG257</b>	18

Surcharge for bevelled profile.

Only on Matt White finish.

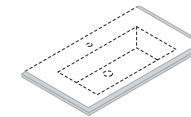
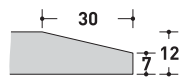

Code	Price
per lm <b>MGB03</b>	69

Matt OCRITECH® Click-Clack drain.

Can be ordered only together the Top.  
Can not be sold separately.



	Code	Price
Chrome	each <b>PL112</b>	60
Matt White	each <b>PL114</b>	97
Glossy White	each <b>PL122</b>	97
Colour	each <b>PL123</b>	97

Drain in Chrome finish, H.4,5 cm without overflow.



At free drain

	Code	Price
Chrome	each <b>PL116</b>	46

Set of recovery.

	Code	Price
each	<b>KT202</b>	110

**Top for overstanding basins.**

Including:  
1 basin hole  
1 mixer hole

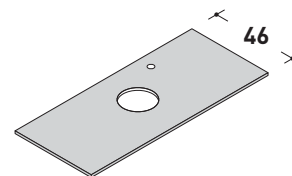
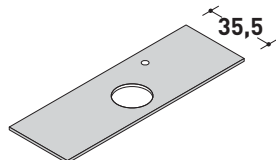

STRAIGHT edge



W	Code	White
70	<b>T0120</b>	284
80	<b>T0121</b>	321
90	<b>T0122</b>	358
100	<b>T0123</b>	394
110	<b>T0124</b>	429
120	<b>T0125</b>	466
130	<b>T0126</b>	503
140	<b>T0127</b>	539
150	<b>T0128</b>	576
160	<b>T0129</b>	611
170	<b>T0130</b>	647
180	<b>T0131</b>	685
190	<b>T0132</b>	721
200	<b>T0133</b>	757
210	<b>T0134</b>	791
220	<b>T0135</b>	828
230	<b>T0136</b>	865
240	<b>T0137</b>	901
250	<b>T0138</b>	939
260	<b>T0139</b>	977
270	<b>T0140</b>	1.015
280	<b>T0141</b>	1.052
290	<b>T0142</b>	1.089

Note: For middle measures always consider the wider article.

W	Code	White
70	<b>T0500</b>	316
80	<b>T0501</b>	355
90	<b>T0502</b>	377
100	<b>T0503</b>	425
110	<b>T0504</b>	460
120	<b>T0505</b>	498
130	<b>T0506</b>	535
140	<b>T0507</b>	571
150	<b>T0508</b>	607
160	<b>T0509</b>	642
170	<b>T0510</b>	679
180	<b>T0511</b>	715
190	<b>T0512</b>	751
200	<b>T0513</b>	787
210	<b>T0514</b>	825
220	<b>T0515</b>	861
230	<b>T0516</b>	896
240	<b>T0517</b>	933
250	<b>T0518</b>	971
260	<b>T0519</b>	1.009
270	<b>T0520</b>	1.044
280	<b>T0521</b>	1.082
290	<b>T0522</b>	1.118

Note: For middle measures always consider the wider article.

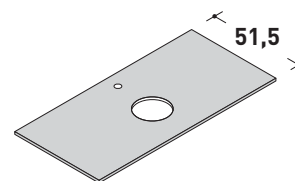

W	Code	White
70	<b>T0150</b>	316
80	<b>T0151</b>	355
90	<b>T0152</b>	377
100	<b>T0153</b>	425
110	<b>T0154</b>	460
120	<b>T0155</b>	498
130	<b>T0156</b>	535
140	<b>T0157</b>	571
150	<b>T0158</b>	607
160	<b>T0159</b>	642
170	<b>T0160</b>	679
180	<b>T0161</b>	715
190	<b>T0162</b>	751
200	<b>T0163</b>	787
210	<b>T0164</b>	825
220	<b>T0165</b>	861
230	<b>T0166</b>	896
240	<b>T0167</b>	933
250	<b>T0168</b>	972
260	<b>T0169</b>	1.011
270	<b>T0145</b>	1.050
280	<b>T0146</b>	1.089
290	<b>T0147</b>	1.128

Note: For middle measures always consider the wider article.

**Surcharge for overstanding additional holes (tap and basin).**

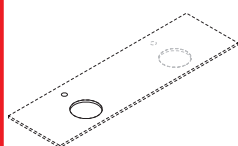

Code	Price
<b>MG156</b>	47

**Top with molded bowl.**

Including:  
1 mixer hole  
1 mixer hole  
For basin type see page 82

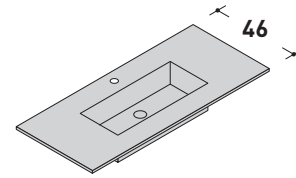

STRAIGHT edge



W	Code	White
70	<b>T0440</b>	410
80	<b>T0441</b>	446
90	<b>T0442</b>	482
100	<b>T0443</b>	519
110	<b>T0444</b>	554
120	<b>T0445</b>	592
130	<b>T0446</b>	627
140	<b>T0447</b>	664
150	<b>T0448</b>	700
160	<b>T0449</b>	735
170	<b>T0450</b>	773
180	<b>T0451</b>	809
190	<b>T0452</b>	845
200	<b>T0453</b>	882
210	<b>T0454</b>	919
220	<b>T0455</b>	954
230	<b>T0456</b>	990
240	<b>T0457</b>	1.027
250	<b>T0458</b>	1.067
260	<b>T0459</b>	1.109
270	<b>T0460</b>	1.150
280	<b>T0461</b>	1.188
290	<b>T0462</b>	1.229

Note: For middle measures always consider the wider article.

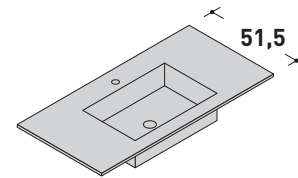

W	Code	White
70	<b>T0280</b>	410
80	<b>T0281</b>	446
90	<b>T0282</b>	482
100	<b>T0283</b>	519
110	<b>T0284</b>	554
120	<b>T0285</b>	592
130	<b>T0286</b>	627
140	<b>T0287</b>	664
150	<b>T0288</b>	700
160	<b>T0289</b>	735
170	<b>T0290</b>	773
180	<b>T0291</b>	809
190	<b>T0292</b>	845
200	<b>T0293</b>	882
210	<b>T0294</b>	919
220	<b>T0295</b>	954
230	<b>T0296</b>	990
240	<b>T0297</b>	1.027
250	<b>T0298</b>	1.070
260	<b>T0299</b>	1.113
270	<b>T0300</b>	1.155
280	<b>T0301</b>	1.198
290	<b>T0302</b>	1.241

Note: For middle measures always consider the wider article.

**Surcharge for additional moulded bowls (and tap hole).**

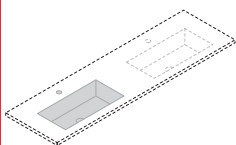

Code	Price
<b>MG306</b>	167

**Boxed top for overstanding basins.**

Including:  
1 basin hole  
1 mixer hole

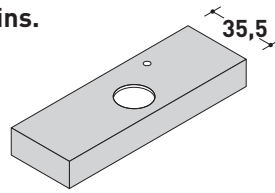

★ Thickness may vary between 6-12cm with no surcharge. For standard brackets, minimum height is 9,5cm.

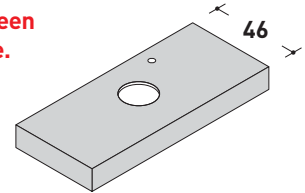

**BOXED edge**

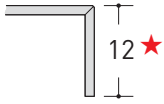

W	Code	White
70	<b>T0310</b>	412
80	<b>T0311</b>	461
90	<b>T0312</b>	512
100	<b>T0313</b>	561
110	<b>T0314</b>	613
120	<b>T0315</b>	664
130	<b>T0316</b>	713
140	<b>T0317</b>	764
150	<b>T0318</b>	814
160	<b>T0319</b>	864
170	<b>T0320</b>	916
180	<b>T0321</b>	965
190	<b>T0322</b>	1.016
200	<b>T0323</b>	1.066
210	<b>T0324</b>	1.116
220	<b>T0325</b>	1.166
230	<b>T0326</b>	1.218
240	<b>T0327</b>	1.268
250	<b>T0328</b>	1.320
260	<b>T0329</b>	1.373
270	<b>T0330</b>	1.426
280	<b>T0331</b>	1.479
290	<b>T0332</b>	1.532

Note: For middle measures always consider the wider article.

W	Code	White
70	<b>T0530</b>	443
80	<b>T0531</b>	495
90	<b>T0532</b>	549
100	<b>T0533</b>	603
110	<b>T0534</b>	658
120	<b>T0535</b>	712
130	<b>T0536</b>	767
140	<b>T0537</b>	820
150	<b>T0538</b>	875
160	<b>T0539</b>	929
170	<b>T0540</b>	984
180	<b>T0541</b>	1.038
190	<b>T0542</b>	1.092
200	<b>T0543</b>	1.146
210	<b>T0544</b>	1.199
220	<b>T0545</b>	1.254
230	<b>T0546</b>	1.308
240	<b>T0547</b>	1.363
250	<b>T0548</b>	1.418
260	<b>T0549</b>	1.473
270	<b>T0550</b>	1.528
280	<b>T0551</b>	1.583
290	<b>T0552</b>	1.638

Note: For middle measures always consider the wider article.

**ALWAYS required support brackets for boxed tops**

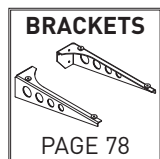

★ Thickness may vary between 6-12cm with no surcharge. For standard brackets, minimum height is 9,5cm.

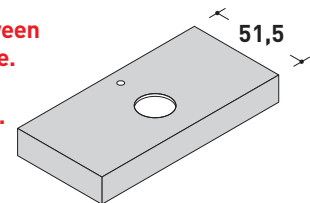

W	Code	White
70	<b>T0340</b>	443
80	<b>T0341</b>	495
90	<b>T0342</b>	549
100	<b>T0343</b>	603
110	<b>T0344</b>	658
120	<b>T0345</b>	712
130	<b>T0346</b>	767
140	<b>T0347</b>	820
150	<b>T0348</b>	875
160	<b>T0349</b>	929
170	<b>T0350</b>	984
180	<b>T0351</b>	1.038
190	<b>T0352</b>	1.092
200	<b>T0353</b>	1.146
210	<b>T0354</b>	1.199
220	<b>T0355</b>	1.254
230	<b>T0356</b>	1.308
240	<b>T0357</b>	1.363
250	<b>T0358</b>	1.421
260	<b>T0359</b>	1.478
270	<b>T0493</b>	1.534
280	<b>T0494</b>	1.591
290	<b>T0495</b>	1.648

Note: For middle measures always consider the wider article.

**Surcharge overstanding additional holes.**

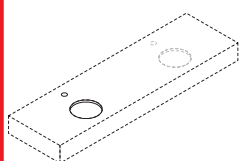

Code	Price
<b>MG156</b>	47



**Boxed top with molded bowl.**

Including:  
single bowl  
1 mixer hole

For basin type see page 82

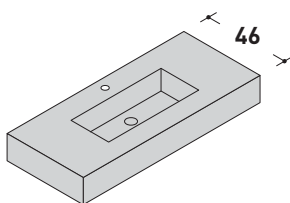

★ Thickness may vary between 6-12cm with no surcharge. For standard brackets, minimum height is 9,5cm.

BOXED edge

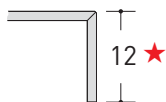

min 70 - max 290

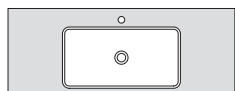

min. 10 min. 10

Always leave 10 cm space for brackets installation

**ALWAYS required support brackets for boxed tops**

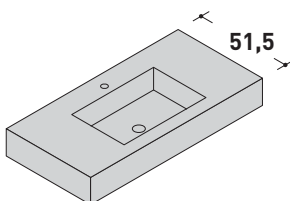
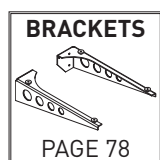

★ Thickness may vary between 6-12cm with no surcharge. For standard brackets, minimum height is 9,5cm.

**IMPORTANT:**  
if it is placed on a furniture, the basin **MUST** be positioned **COMPLETELY** inside the washbasin base.

W	Code	White
70	<b>T0470</b>	537
80	<b>T0471</b>	590
90	<b>T0472</b>	644
100	<b>T0473</b>	698
110	<b>T0474</b>	752
120	<b>T0475</b>	807
130	<b>T0476</b>	861
140	<b>T0477</b>	916
150	<b>T0478</b>	968
160	<b>T0479</b>	1.023
170	<b>T0480</b>	1.077
180	<b>T0481</b>	1.131
190	<b>T0482</b>	1.186
200	<b>T0483</b>	1.240
210	<b>T0484</b>	1.294
220	<b>T0485</b>	1.348
230	<b>T0486</b>	1.403
240	<b>T0487</b>	1.457
250	<b>T0488</b>	1.512
260	<b>T0489</b>	1.567
270	<b>T0490</b>	1.625
280	<b>T0491</b>	1.679
290	<b>T0492</b>	1.732

Note: For middle measures always consider the wider article.

**IMPORTANT:**  
if it is placed on a furniture, the basin **MUST** be positioned **COMPLETELY** inside the washbasin base.

W	Code	White
70	<b>T0400</b>	537
80	<b>T0401</b>	590
90	<b>T0402</b>	644
100	<b>T0403</b>	698
110	<b>T0404</b>	752
120	<b>T0405</b>	807
130	<b>T0406</b>	861
140	<b>T0407</b>	916
150	<b>T0408</b>	968
160	<b>T0409</b>	1.023
170	<b>T0410</b>	1.077
180	<b>T0411</b>	1.131
190	<b>T0412</b>	1.186
200	<b>T0413</b>	1.240
210	<b>T0414</b>	1.294
220	<b>T0415</b>	1.348
230	<b>T0416</b>	1.403
240	<b>T0417</b>	1.457
250	<b>T0418</b>	1.518
260	<b>T0419</b>	1.579
270	<b>T0496</b>	1.639
280	<b>T0497</b>	1.700
290	<b>T0498</b>	1.760

Note: For middle measures always consider the wider article.

**Surcharge for additional moulded bowls.**

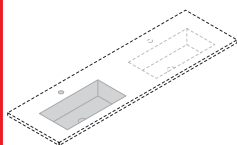

Code	Price
<b>MG306</b>	167



# Compositions

**Basin excluded if not in the list of the items  
Taps ALWAYS excluded**

Price Groups

13	2	3
<b>Polymeric</b>	<b>Matt White</b>	<b>Matt Colour</b>

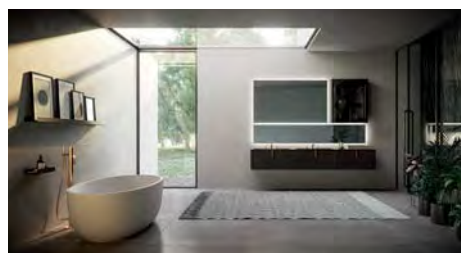

**COMP 1** (pages 04-09)  
 Dimensions: 230 x 51 mm  
 Furniture finish: L025M Grey Brown Matt lacquered  
 Top finish: Gres Laminam noir desir  
 Handle: Cylinder Ottone Art  
**Price as shown: 6.863**

Q.ty	Code	W	D	H	Description	6.717	6.804	6.863
2	<b>BL1617C</b>	80	51	36	Washbasin unit 1 jumbo metal drawer	898	944	980
1	<b>BA1608C</b>	70	51	36	Base unit 1 jumbo metal drawer	365	383	398
1	<b>TM476</b>	230	51	1,2	Top Gres Laminam with moulded bowl	2.890	2.890	2.890
1	<b>MG301</b>				Surcharge for additional moulded bowl	879	879	879
1	<b>SL4900</b>	220	2,5	32	LUX 4 mirror per sq.m. with LED lighting	328	328	328
1	<b>SL4900</b>	145	2,5	84	LUX 4 mirror per sq.m. with LED lighting	568	568	568
1	<b>PV264</b>	70	21	84	Wall unit 2 doors with black aluminium frame + Stop-sol glass	690	713	721
3	<b>MG242</b>				Surcharge for handle in Art Brass finish	99	99	99



**COMP 2** (pages 10-15)  
 Dimensions: 84 x 46 mm  
 Furniture finish: L001M White Matt lacquered  
 Top finish: Slim Ceramic Console  
 Handle: PROFILO Black  
**Price as shown: 4.603**

Q.ty	Code	W	D	H	Description	4.507	4.603	4.737
1	<b>MB222C</b>	80	46	72	Uniblock 2 jumbo metal drawers	753	791	821
1	<b>CS08040</b>	80	46	12	SLIM Console	451	451	451
1	<b>SP891</b>	90	2,5	90	SPHERA 2 mirror with LED lights on the edge	363	363	363
2	<b>CV637</b>	70	35	165	Wall unit 4 doors with black aluminium frame + Stop-sol glass	2.548	2.606	2.710
2	<b>FA338</b>	26	3	26	RING ceiling suspension lamp, Matt Black finish	392	392	392



**COMP 3** (pages 16-21)  
 Dimensions: 150 x 51 mm  
 Furniture finish: 186X Polymeric Dark Rockford  
 Top finish: HPL Ossido  
 Handle: PROFILO Black  
**Price as shown: 3.544**

Q.ty	Code	W	D	H	Description	3.544	3.625	3.678
1	<b>BV1608C</b>	70	51	36	Base unit 1 jumbo metal drawer w/black aluminium frame + Stop-sol glass	462	486	504
1	<b>BL961C</b>	80	51	60	Washbasin unit 2 jumbo metal drawers	667	701	728
1	<b>TH104</b>	71	51	1,2	Top HPL	155	155	155
1	<b>TH281</b>	81	51	1,2	Top HPL with moulded bowl	1.107	1.107	1.107
1	<b>SP920</b>	80	2,5	84	BASIC mirror by Square Meter with Matt Black frame	259	259	259
1	<b>PV264</b>	70	21	84	Wall unit 2 doors with black aluminium frame + Stop-sol glass	690	713	721
1	<b>FA347</b>	50	1,5	1,5	Vertigo lamp	146	146	146
1	<b>AS600</b>	40	13,4	5,3	Metal towel holder BLADE	58	58	58

**Basin excluded if not in the list of the items  
Taps ALWAYS excluded**

Price Groups

13	2	3
<b>Polymeric</b>	<b>Matt White</b>	<b>Matt Colour</b>



## COMP 4 (pages 22-27)

Dimensions: 182 x 51 mm  
 Furniture finish: 189X Polymeric Fruit Wood  
 Top finish: 189X Polymeric Fruit Wood  
 Handle: Push  
**Price as shown: 4.477**

Q.ty	Code	W	D	H	Description	4.477	4.625	4.668
1	BA1608C	70	51	36	Base unit 1 jumbo metal drawer	365	383	398
1	BL1618C	90	51	36	Washbasin unit 1 jumbo metal drawer	468	492	511
1	TL109	72	51	1,9	Overall plate WITHOUT HOLE in Polymeric	105	162	171
1	FN112	1,9	51	36	Cannetted side panel	69	118	118
1	COL147	110	51	48	WRAP 1 Ocritech console with towel compartment	1.914	1.914	1.914
1	SP920	180	2,5	84	BASIC mirror by Square Meter with Matt Black	582	582	582
1	FA348	180	1	1	STICK lamp per linear meter in Black finish	283	283	283
1	ST35117	35	19	117	Open element with finished back panel	477	477	477
1	AS604	60	13,4	5,3	Q Wall shelf	70	70	70
2	MG247				Surcharge for Push-pull opening on drawer	144	144	144



## COMP 5 (pages 28-33)

Dimensions: 70 x 51 mm  
 Furniture finish: 186X Polymeric Dark Rockford  
 Top finish: Ocritech  
 Handle: Cylinder  
**Price as shown: 3.176**

Q.ty	Code	W	D	H	Description	3.176	3.372	3.542
4	PI150	2,9	2,9	21	Vertigo foot	264	264	264
1	BL75D5	70	51	72	Washbasin unit 2 jumbo metal drawers	734	772	801
2	FC115	1,9	51	72	Round shape smooth finish side	218	230	230
1	T0281	75	51	1,2	Top Ocritech with moulded bowl	446	580	698
1	SP920	75	2,5	117	BASIC mirror by Square Meter with Matt Black frame	338	338	338
1	FA347	50	1,5	1,5	Vertigo lamp	146	146	146
1	PE373	25	21	117	Open tall unit with with 3 shelves	504	486	504
1	PV270	35	21	117	Wall unit 1 door with black aluminium frame + Stop-sol glass	526	556	561



## COMP 6 (pages 34-39)

Dimensions: 240 x 51 mm  
 Furniture finish: 187X Polymeric Bourbon Oak  
 Top finish: 187X Polymeric Bourbon Oak  
 Handle: Push  
**Price as shown: 3.426**

Q.ty	Code	W	D	H	Description	3.426	3.679	3.759
2	BA1617C	80	51	36	Base unit 1 jumbo metal drawer	762	802	832
1	BL1617C	80	51	36	Washbasin unit 1 jumbo metal drawer	449	472	490
1	TL167	240	51	1,9	Top for overstanding basins. in Polymeric	379	569	601
1	LB781	85	37	12	HIDE 85 washbasin	1.075	1.075	1.075
2	SL4900	45	2,5	130	LUX 4 mirror per sq.m. with LED lighting	545	545	545
3	MG247				Surcharge for Push-pull opening on drawer	216	216	216

# Catalog compositions

**Basin excluded if not in the list of the items  
Taps ALWAYS excluded**

Price Groups

13	2	3
<b>Polymeric</b>	<b>Matt White</b>	<b>Matt Colour</b>



## COMP 7 (pages 40-45)

Dimensions: 150 x 51 mm  
 Furniture finish: 184X Polymeric Bronze metallik  
 Top finish: 188X Polymeric Thermo A Push  
 Handle: **3.365**  
**Price as shown:**

Q.ty	Code	W	D	H	Description	3.365	3.612	3.717
1	BA1607C	50	51	36	Base unit 1 jumbo metal drawer	324	340	354
1	BA1609C	100	51	36	Base unit 1 jumbo metal drawer	418	439	457
1	TL109	150	51	1,9	Overail plate WITHOUT HOLE in Polymeric	219	338	357
1	TL218	150	51	12	Boxed top for overstanding basins in Polymeric	541	632	686
1	SP466	80	2,5	80	OTTAGONO SMALL mirror	358	358	358
2	ST3030	30	19	30	Open element with finished back panel	518	518	518
3	SS804				Brackets for boxed tops	411	411	411
1	LB735	42	42	14	B387 Tecnoril washbasin	432	432	432
2	MG247				Surcharge for Push-pull opening on drawer	144	144	144



## COMP 8 (pages 46-51)

Dimensions: 179 x 51 mm  
 Furniture finish: 183X Polymeric Rovere Grain  
 Top finish: Laminam Statuarietto  
 Handle: Push  
**Price as shown: 6.299**

Q.ty	Code	W	D	H	Description	6.299	6.522	6.633
1	FN113	1,9	51	48	Cannetted side panel	84	150	150
1	BA1451C	50	51	48	Base unit 2 jumbo metal drawers	459	482	501
1	BA1413	35	51	48	Open base unit	479	479	514
1	BL1472C	90	51	48	Washbasin unit 2 jumbo metal drawers	624	656	681
1	FN113	1,9	51	48	Cannetted side panel	84	150	150
1	TM406	127	51	6	Boxed top with moulded bowl in Gres Laminam	2.133	2.133	2.133
1	TM105	52	51	1,2	Overail plate WITHOUT HOLE in Gres Laminam	410	410	410
1	SP920	175	2,5	75	BASIC mirror by Square Meter with Matt Black	505	505	505
1	FA343	40	4	4	DUAL lamp in Matt Black finish	160	160	160
1	PV260	35	21	84	Wall unit 1 door with black aluminium frame + Stop-sol glass	416	443	447
1	PV212	35	21	48	Wall unit 1 door with black aluminium frame + Stop-sol glass	328	337	348
1	PE355	70	21	16	Open tall unit per lm. with 1 internal fixed division	329	329	346
4	MG247				Surcharge for Push-pull opening on drawer	288	288	288



## COMP 9 (pages 52-57)

Dimensions: 155 x 51 mm  
 Furniture finish: L006M Light Grey Matt lacquered - L012M Dusty Grey Matt lacquered  
 Top finish: Deimos Cemento  
 Handle: PROFILO Black  
**Price as shown: 3.302**

Q.ty	Code	W	D	H	Description	3.228	3.240	3.302
1	BL073C	120	51	24	Washbasin unit 1 jumbo metal drawer	451	475	492
1	BA089C	100	51	24	Base unit 1 jumbo metal drawer	366	384	399
1	PV82L3	50	21	84	COMBO wall unit 1 door with black aluminium frame	607	577	607
1	SP920	140	2,5	84	BASIC mirror by Square Meter with Matt Black frame	453	453	453
1	FA347	50	1,5	1,5	Vertigo lamp	146	146	146
1	TD285	121	51	1,2	Top with moulded bowl in Deimos	1.026	1.026	1.026
1	TD104	35	51	1,2	Overail plate WITHOUT HOLE in Deimos	180	180	180

**Basin excluded if not in the list of the items  
Taps ALWAYS excluded**

Price Groups

13	2	3
<b>Polymeric</b>	<b>Matt White</b>	<b>Matt Colour</b>



**COMP 10** (pages 58-63)

Dimensions: 154 x 54 mm  
 Furniture finish: L054G Bruma Gloss lacquered - L054M Bruma Matt lacquered  
 Top finish: Tecnoril with integrated bowl  
 Handle: Cylinder  
**Price as shown: 4.715**

Q.ty	Code	W	D	H	Description	4.403	4.492
1	<b>BA1466C</b>	60	51	48	Base unit 2 jumbo metal drawers (mod. ModulaDue see G.PL.)	509	528
1	<b>BL1472C</b>	90	51	48	Washbasin unit 2 jumbo metal drawers	656	681
1	<b>TT589</b>	154	54	1,9	Top with moulded bowl in Tecnoril	1.644	1.644
1	<b>PD1950</b>	154	54	1,9	45° bevelled lower wooden bottom	447	470
2	<b>FN522</b>	2	54	52	Side with 45° bevelled edges	306	328
1	<b>SP802</b>	80	4,5	84	BLACK mirror w/matt Black aluminium frame and LED	359	359
1	<b>SP802</b>	80	4,5	84	BLACK mirror w/matt Black aluminium frame and LED	359	359
1	<b>AS603</b>	30	13,4	5,3	Wall shelf BLADE	53	53
1	<b>AS604</b>	60	13,4	5,3	Wall shelf BLADE	70	70



**COMP 11** (pages 64-69)

Dimensions: 119 x 51 mm  
 Furniture finish: 188X Polymeric THERMO A  
 Top finish: 188X Polymeric THERMO A  
 Handle: Push  
**Price as shown: 2.586**

Q.ty	Code	W	D	H	Description	2.586	2.883	2.944
1	<b>FN113</b>	1,9	51	48	Cannetted side panel	84	150	150
1	<b>BL1467C</b>	80	51	48	Washbasin unit 2 jumbo metal drawers	601	632	656
1	<b>BA1451C</b>	50	51	48	Base unit 2 jumbo metal drawers	459	482	501
1	<b>FN113</b>	1,9	51	48	Cannetted side panel	84	150	150
4	<b>PI160</b>	2,9	2,9	33	Vertigo foot	440	440	440
1	<b>TL157</b>	134	51	1,9	Top for overstanding basins in Polymeric	234	345	363
1	<b>SP461</b>	72	4,5	72	SUN mirror, with Brass frame and LED lighting	396	396	396
4	<b>MG247</b>				Surcharge for Push-pull opening on drawer	288	288	288



**COMP 12** (pages 70-75)

Dimensions: 119 x 51 mm  
 Furniture finish: L007M Silk Grey Matt lacquered  
 Top finish: Calacatta Marble  
 Handle: Push  
**Price as shown: 4.026**

Q.ty	Code	W	D	H	Description	4.026	4.033	4.094
1	<b>GF573</b>	7	51	73	Pair of sides ART	762	731	762
1	<b>BL1628C</b>	70	51	36	Washbasin unit 1 jumbo metal drawer	435	457	475
1	<b>BA1606C</b>	35	51	36	Base unit 1 jumbo metal drawer	296	312	324
1	<b>TM155</b>	120	51	2	Top for overstanding basins in Marble	626	626	626
1	<b>MGB01</b>				Surcharge for bevelled profile	219	219	219
1	<b>LB697</b>	58	38	14	SKIN RETTANGOLARE LAY-ON washbasin	420	420	420
1	<b>SP471</b>	80	2,5	110	OTTAGONO BIG mirror.with LED lighting	414	414	414
2	<b>FA339</b>	26	3	26	RING ceiling suspension lamp, in Brass finish	710	710	710
2	<b>MG247</b>				Surcharge for Push-pull opening on drawer	144	144	144

**Basin excluded if not in the list of the items  
Taps ALWAYS excluded**

Price Groups

13	2	3
<b>Polymeric</b>	<b>Matt White</b>	<b>Matt Colour</b>



## COMP 12-V (pages 76-77)

Dimensions: 119 x 51 mm  
 Furniture finish: L007M Silk Grey Matt lacquered  
 Top finish: Calacatta Marble  
 Handle: PROFILO Black  
**Price as shown: 5077**

Q.ty	Code	W	D	H	Description	£4975	£4988	£5077
1	<b>GF573</b>	7	51	73	Pair of sides ART	914	877	924
2	<b>MGP10</b>				Surcharge for Matt Black finish feet	199	199	199
1	<b>BL1628C</b>	70	51	36	Washbasin unit 1 jumbo metal drawer	522	548	570
1	<b>BV1606C</b>	35	51	36	Base unit 1 jumbo metal drawer w/black aluminium frame + Stop-sol glass	475	499	519
1	<b>TM155</b>	120	51	2	Top for overstanding basins in Marble	751	751	751
1	<b>MGB01</b>				Surcharge for bevelled profile	262	262	262
1	<b>LB697</b>	58	38	14	SKIN RETTANGOLARE LAY-ON washbasin	504	504	504
1	<b>SP471</b>	80	2,5	110	OTTAGONO BIG mirror with LED lighting	496	496	496
2	<b>FA338</b>	26	3	26	RING ceiling suspension lamp, Matt Black finish	852	852	852



## COMP 13 (pages 78-83)

Dimensions: 150 x 51 mm  
 Furniture finish: 189X Polymeric Fruit Wood  
 Top finish: Gres Emperador  
 Handle: Cylinder Ottone Art  
**Price as shown: 4.653**

Q.ty	Code	W	D	H	Description	4.653	4.715	4.766
1	<b>BA951C</b>	60	51	60	Base unit 2 jumbo metal drawers	544	571	593
1	<b>BL962C</b>	90	51	60	Washbasin unit 2 jumbo metal drawers	700	735	764
1	<b>TM468</b>	151	51	1,2	Top with moulded bowl in Gres	2.287	2.287	2.287
4	<b>PI160</b>	2,9	2,9	33	Vertigo foot	440	440	440
1	<b>SP893</b>	110	2,5	110	SPHERA 2 mirror with LED lights on the edge	432	432	432
1	<b>AS602</b>	60	13,4	5,3	Shaped shelf BLADE, to match with wall mirrors	118	118	118
4	<b>MG242</b>				Surcharge for handle in Art Brass finish	132	132	132



## COMP 14 (pages 84-89)

Dimensions: 189 x 51 mm  
 Furniture finish: L048M Ocean Blue Matt lacquered  
 Top finish: Ocean Blue lacquered glass  
 Handle: Cylinder Art Brass finish  
**Price as shown: 5.581**

Q.ty	Code	W	D	H	Description	5.581	5.643	5.746
1	<b>GF585</b>	7	51	85	Pair of sides ART	836	806	836
1	<b>BL1466C</b>	70	51	48	Washbasin unit 2 jumbo metal drawers	577	607	630
1	<b>BV1447C</b>	35	51	48	Base unit 2 jumbo metal drawers w/black aluminium frame + Stop-sol glass	638	670	697
1	<b>BL1466C</b>	70	51	48	Washbasin unit 2 jumbo metal drawers	577	607	630
1	<b>TV292</b>	190	51	1	Top with moulded bowl in lacquered glass	1.405	1.405	1.405
1	<b>MG304</b>				Surcharge for additional moulded bowl	534	534	534
2	<b>SL4900</b>	70	2,5	110	LUX 4 mirror per sq.m. with LED lighting	718	718	718
1	<b>SL4900</b>	32	2,5	110	LUX 4 mirror per sq.m. with LED lighting	164	164	164
4	<b>MG242</b>				Surcharge for handle in Art Brass finish	132	132	132







Stonewood UK LTD 3-5 Buxton Road, Hazel Grove, Stockport, Cheshire, SK7 6AD  
TEL 01614839120 Email: [sales@stonewood.uk.com](mailto:sales@stonewood.uk.com)